



Smartfind M15

AIS RECEIVER

USER MANUAL

Smartfind M15, M15S
AIS Receiver
User Manual

General Information

i. Copyright

The entire contents of this instruction manual, including any future updates, revisions, and modifications, shall remain the property of Netwave Systems B.V. at all times. Unauthorized copies or reproduction of this manual, either in part or whole, in any form of print and electronic media, is prohibited. The contents herein can only be used for the intended purpose of this manual.

ii. Disclaimer

The information and illustrations contained in this publication are to the best of our knowledge correct at the time of going to print. We reserve the right to change specifications, equipment, installation and maintenance instructions without notice as part of our policy of continuous product development and improvement. No part of this publication may be reproduced, stored in a retrieval system or transmitted in any form, electronic or otherwise without

permission in writing from Netwave Systems B.V. No liability can be accepted for any inaccuracies or omissions in the publication, although every care has been taken to make it as complete and accurate as possible.

This manual is applicable for all versions of the McMurdo Smartfind M15 devices manufactured after March 2014.

iii. **Safety Warning**



It is important to know that AIS is designed for the purpose of anti-collision and serves as a complement to navigation. It is not the absolute navigational equipment and does not replace any navigational system installed on board.

Any AIS device cannot guarantee monitoring and receiving signals from all vessels in the surroundings unless those vessels are equipped with AIS devices.



ELECTRICAL SHOCK HAZARD

Improper disassembly or modification could cause electrical shocks, fire, or personal injury. Contains no user-serviceable parts.



CORRECT POWER SOURCE

An incorrect power source will damage the equipment and may even result in a fire. Ensure that the correct power source is provided at all times.



AVOID DIRECT CONTACT WITH RAIN OR SPLASHING WATER

Electrical shock or fire could be resulted if water leaks into the equipment.



AVOID USING CHEMICAL SOLVENTS TO CLEAN THE CASE

As some solvents can damage the case material.



NOTE/INFORMATION

Throughout this manual this symbol indicates important information.

iv. Product Category

This product is categorized as “protected” in accordance with the requirements as defined in IEC 60945.

v. Hardware / Software Version

The model name/number, hardware information, and firmware (software) version of the receiver can be identified through using the McMurdo AIS Receiver Config software supplied. The software maintenance/upgrade of the receiver can be carried out via the USB interface.

vi. Declaration of Conformity

Hereby Netwave Systems B.V. declares that the Type Z604 (M15) & Z605 (M15S) is in compliance with the essential requirements and other relevant provisions of the Radio

Equipment Directive (RED) 2014/53/EU on radio and telecommunications terminal equipment. A copy of the Declaration of Conformity can be obtained on-line from: <https://www.seasofsolutions.com/products/mcmurdo-smartfind-m15-m15s-ais-receiver/>

vii. **FCC Interference Statement**

NOTE: This equipment has been tested and found to comply with the limits for a Class A digital device, pursuant to part 15 of the FCC Rules. These limits are designed to provide reasonable protection against harmful interference when the equipment is operated in a commercial environment. This equipment generates, uses, and can radiate radio frequency energy and, if not installed and used in accordance with the instruction manual, may cause harmful interference to radio communications. Operation of this equipment in a residential area is likely to cause harmful interference in

which case the user will be required to correct the interference at his own expense.

This device complies with Part 15 of the FCC Rules. Operation is subject to the following two conditions:

- 1) This device may not cause harmful interference, and
- 2) This device must accept any interference received, including interference that may cause undesired operation

viii. Disposal Instruction

The Waste Electrical and Electronic Equipment (WEEE) Directive aims to minimize any adverse impact of electronic equipment on the environment, both during the product lifetime and when it becomes waste. Within the European Union this legislation is mandated by Directive 2002/96/EC, and there is similar legislation in most other continents. The directive applies to all electronic products

such as IT, household appliances, portable electronics etc., and imposes requirements to collect, treat, recover and recycle each product at its end of life. Electronic end-user products must also carry a WEEE label (as below) and recovery and recycling information has to be provided to the recycler.



ix. **IMO Green Passport Ship Recycling Information**

Netwave Systems B.V. hereby declares potentially hazardous content in some of its electronic products. Small amounts of the following substances may be present: beryllium oxide, lithium, lead, brominated flame retardants, glass. In keeping with European directive 2002/96/EC (Waste Electronic and Electrical Equipment) and the provisions of IMO Resolution A.962 (23)

(Guidelines On Ship Recycling), Netwave Systems B.V. strongly recommends that its products, including any battery packs, be disposed of in a considerate and legal manner.

x. **Maintenance**

All servicing must be carried out by an Netwave Systems B.V. approved service agent. Always call your nearest agent and talk to their service department before returning equipment. You can find your nearest service agent from:

- The McMurdo web site:
www.seasofsolutions.com/
- You can also send an email to customer.service@seasofsolutions.com and someone will be in touch to answer your service and support questions.
- Or contact our offices:
Netwave Systems B.V.
Blauw-roodlaan 100,

2718 SJ Zoetermeer, Netherlands
Phone: +31 (0) 8811 81500

xi. Contact Information

For sales, services, and technical supports, please contact your local Netwave Systems representatives or Netwave Systems B.V at www.seasofsolutions.com or email to customer.service@seasofsolutions.com

TABLE OF CONTENT

1	INTRODUCTION	15
1.1	ABOUT THIS MANUAL	15
1.2	SMARTFIND M15 OVERVIEW	15
1.3	COMPARISON OF SMARTFIND M15 SERIES	18
1.4	TYPE OF AIS	19
1.5	AIS MESSAGE TYPE	20
1.6	IMPORTANT NOTICE	22
2	GETTING STARTED	23
2.1	ITEMS IN THE PACKAGE	23
2.2	POWER ON / OFF	25
2.3	SMARTFIND M15 LED INDICATORS	26
3	INSTALLATION	27
3.1	SMARTFIND M15 CONNECTION INTERFACE	27
3.2	INSTALLATION PRECAUTIONS	28
3.3	MOUNTING INSTRUCTIONS	29
3.4	WIRING DETAILS	31
3.5	NMEA WIRING INSTRUCTIONS	32
3.5.1	NMEA0183 RS422 Connection	32

3.5.2	RS232 Connection	33
3.5.3	Twin RS232 Connection	34
3.6	VHF ANTENNA INSTALLATION.....	36
3.7	USB DRIVER INSTALLATION	38
3.8	SMARTFIND M15 CONFIGURATION SOFTWARE.....	40
3.8.1	Software Installation	40
3.8.2	Configuration.....	44
3.8.3	Diagnosis.....	46
3.9	NMEA 0183 MULTIPLEXER	49
3.10	McMURDO AIS VIEWER SOFTWARE	51
3.11	CONNECTING YOUR RECEIVER TO MACINTOSH	52
4	APPENDIX	53
4.1	PRODUCT SPECIFICATIONS.....	53
4.2	DIMENSIONS	58
4.3	ACCESSORIES (OPTIONAL).....	59
5	SCHEDULE OF PRODUCT WARRANTY (MCMURDO LTD)	60
6	ACRONYMS	63

1 INTRODUCTION

1.1 About This Manual

This manual contains installation instructions and operating information for different McMurdo Smartfind M15 models. While most of the installation can be performed by the owner or the crew, a final commissioning can be carried out by your local agent/dealer when needed or required. Netwave Systems B.V. and the local agent/dealer will not bear any responsibilities over any damages resulted in improper installation by unauthorized agent/dealer.

1.2 Smartfind M15 Overview

The McMurdo Smartfind M15 (including variants) is an AIS receiver. It receives AIS navigation data from AIS-equipped vessels nearby and improves navigation safety. Smartfind M15 is designed to inter-operate with AIS Class A, Class B

transponders, AIS SART, AIS MOB, and any other AIS station operating on the AIS VHF data link.

The Smartfind M15 is built with two parallel AIS receivers in one box monitoring the default marine VHF AIS channels, i.e. 161.975 and 162.025 MHz with optimized sensitivity. Having a Smartfind M15 AIS receiver on board, not only can you monitor the status of the vessels in the surrounding area, but also receive the dynamic information (position, speed, SOG, etc.), static information (ship name, MMSI, call sign, etc.), and voyage related information (cargo type, destination, etc.) from any vessels nearby that are equipped with AIS transponders.

The receivers are equipped with standard USB and NMEA0183, the Smartfind M15 allows connectivity to most available peripherals in the market.

The units can be either powered via the USB connection (for M15, serial number 21-305-000106 onwards only) or from an external 12/24V power supply.

Users are able to view AIS information on their preferred PC based navigation systems via the USB interface.

The Smartfind M15 is IPX2 water resistant providing acceptable protection against water, but it does require a protected installation environment away from water.



Figure 1 Smartfind M15

1.3 Comparison of Smartfind M15 Series

Description	Smartfind M15	Smartfind M15S
Number of AIS Channels	2	2
USB port	1	1
NMEA 0183	Independent 1 input, 1 output	Independent 1 input, 1 output
Built-in VHF/AIS antenna splitter	No	Yes

1.4 Type of AIS

The different types of AIS devices are described below. The Smartfind M15 is an AIS receiver.

Class A AIS Transponder	<ul style="list-style-type: none">• Transmits and receives AIS signal.• Intended for vessels meeting the requirements of IMO AIS carriage requirement.• It is mandatory for all commercial vessels that exceed 300 tons to be equipped with Class A AIS.
Class B AIS Transponder	<ul style="list-style-type: none">• Transmits and receives AIS signal.• Not necessarily in full accord with IMO AIS carriage requirements.• It is not mandatory for vessels to be equipped with Class B AIS.• Suitable for recreational vessel, in enhancing its safety at sea.
AIS Receiver	<ul style="list-style-type: none">• Only receives AIS signal.• Does not have transmitter to send out AIS signal.• Suitable for recreational vessel that does not want to send out its vessel information.

1.5 AIS Message Type

The Smartfind M15 can receive AIS messages from both Class A and Class B AIS transponders as well as from AIS Base Stations, AIS AtoN's, and AIS SART/MOB devices. The message types are listed as below table. The messages in grey colour are transmitted only from a Class A AIS device.

Type of Message	Data Details
Static Data	Maritime Mobile Service Identity (hereinafter called "MMSI") number IMO number Call sign and name Type of ship Length and beam GPS Antenna location
Voyage Related Data	Draught of the ship Cargo information Destination Estimate Time of Arrival (hereinafter called "ETA")

<p>Dynamic Data</p>	<p>Position of the vessel Coordinated Universal Time (hereinafter called "Time in UTC".) Course Over Ground (hereinafter called "COG") Speed Over Ground (hereinafter called "SOG") Heading Rate of turn Navigational status</p>
<p>Dynamic Reports</p>	<p>Speed of the ship Status of the ship</p>
<p>Safety Related Message (SRM)</p>	<p>Alarm Safety</p>



1.6 Important Notice



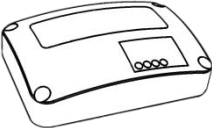

The intended use of the McMurdo Smartfind M15 series Automatic Identification System Receiver is to enhance the safety of vessels at sea. However, a few points must be addressed:

- Under certain regulations, some specified vessels it is compulsory for AIS to be installed. However, this does NOT mean that all vessels will be equipped with AIS. Any AIS will NOT guarantee to monitor and to receive signals from every ship in the surroundings.
- AIS acts as an aid to navigation in the purpose of decreasing or preventing the possibility of vessel collision. It is not the absolute navigational equipment and does not replace any navigational system installed on board.
- This product is a marine AIS receiver intended for worldwide use on NON SOLAS vessels.

2 GETTING STARTED

2.1 Items in the Package

No.	Diagram	Description	Qty
1	 <p>M15</p>	Smartfind M15 AIS Receiver with integrated Power/USB/ NMEA0183 Cable, 1m	1
	 <p>M15S</p>		
	 <p>Cable</p>		

2		User's Manual	1
3		CD-ROM (User's manual in digital format, Configuration Utility, USB driver, AIS Viewer)	1
4		Mounting screws 4 M3.5x25	4
5	 M15S only	VHF cable, 1m (with PL-259 male connectors)	1

Please contact your supplier immediately if there is any item missing.

2.2 Power ON / OFF

All Smartfind M15 models are designed having no physical On/Off switch. Thus, either the vessel's operation determines the unit's power status if connected via the power lead to the vessels power, or the PC that the device is connected via the USB cable if not using vessels power.



Note the unit should be wired using suitable fusing to ensure safe operation and to protect it from damage. A 2 amp fuse or circuit breaker is recommended for this in the cabling from the vessels power source.



If the PC does not recognise the unit after a power cycle, un-plug and re-plug the USB connection to the PC.

2.3 Smartfind M15 LED Indicators

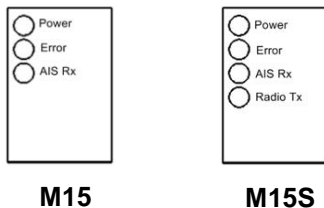

Figure 2 Smartfind M15 LED Indicators

LED INDICATIONS			
Indicator	Indication	Model	Description
Power	Steady Green	M15, M15S	Device in normal operation
Error	Flashing Red	M15, M15S	Error is detected by the on-board system
AIS Rx	Flashing Green	M15, M15S	Receiving of AIS message on either AIS Channel 1 or Channel 2
Radio Tx	Flashing Green	M15S	VHF radio is transmitting

3 INSTALLATION

3.1 Smartfind M15 Connection Interface

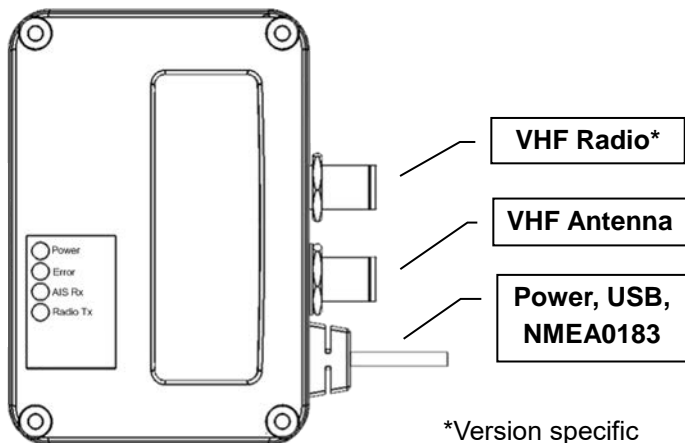

Figure 3 Smartfind M15 Connection Interface

M15 Connections		
Connection	Model	Description
Power, USB, NMEA 0183	M15, M15S	Cables for connecting unit to external devices and power
VHF Antenna	M15, M15S	Antenna connector
VHF Radio	M15S	Radio connector

3.2 Installation Precautions

The Smartfind M15 is IPX2 water resistant providing acceptable protection against water, but it does require a protected installation environment away from water. Find a proper location prior to the installation process. For safety reasons, it's recommended to mount the device not higher than 2m (78.74") above floor-level.

If drilling holes are necessary, always wear eye goggles for protection.

3.3 Mounting Instructions

McMurdo Smartfind M15 can be installed and mounted on either a flat surface or a wall.



The mounting instructions apply to all Smartfind M15 models.

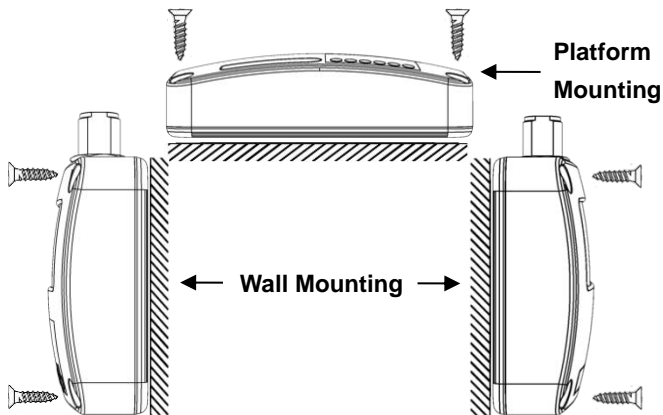
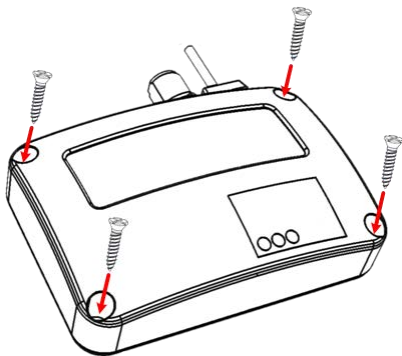

Figure 4 Mounting Instructions (1)



Step 1:

Place the Receiver on the desired location for installing.
(Refer to Figure 4)

Step 2:

Use the provided M3.5x25 screws to mount.

Figure 5 Mounting Instructions (2)

3.4 Wiring Details

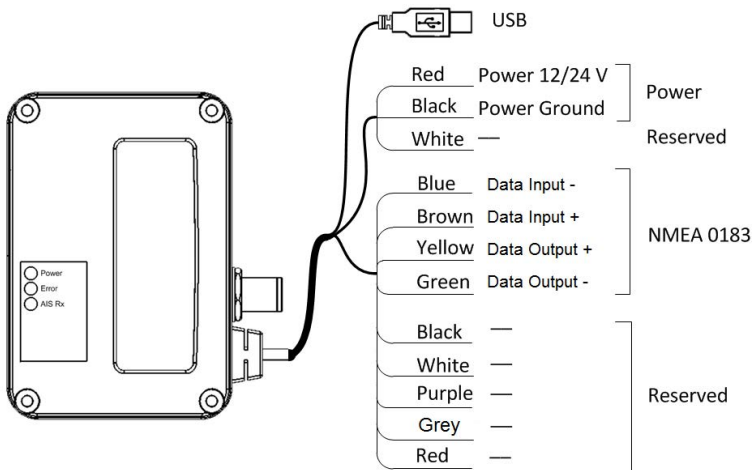
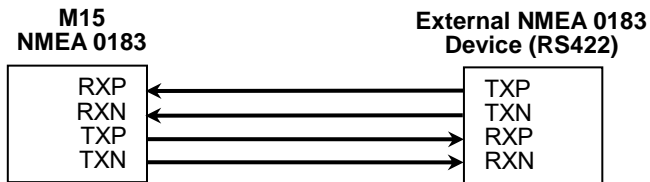

Figure 6 Wiring Details

3.5 NMEA Wiring Instructions



3.5.1 NMEA0183 RS422 Connection

Core Colour at M15	NMEA 0183 Signal	Signal Direction (M15)	External NMEA 0183 Device
Brown	Data Input + (RXP)	Input	Data Output + (TXP)
Blue	Data Input - (RXN)	Input	Data Output - (TXN)
Yellow	Data Output + (TXP)	Output	Data Input + (RXP)
Green	Data Output - (TXN)	Output	Data Input - (RXN)

Figure 7 NMEA0183 Connection illustration

3.5.2 RS232 Connection

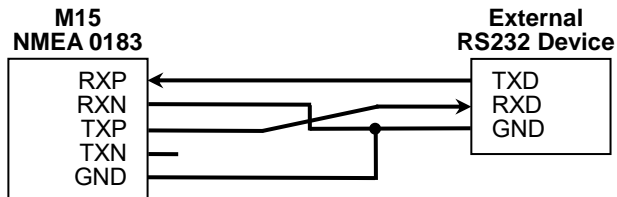

Core Colour at M15	NMEA 0183 Signal	Signal Direction (M15)	External RS-232 Device
Brown	Data Input + (RXP)	Input	Data Output (TXD)
Blue	Data Input - (RXN)	-	Ground
Yellow	Data Output + (TXP)	Output	Data Input (RXD)
Black	Power Ground, (GND)	-	Ground

Figure 8 NMEA0183 to RS232 Connection

3.5.3 Twin RS232 Connection

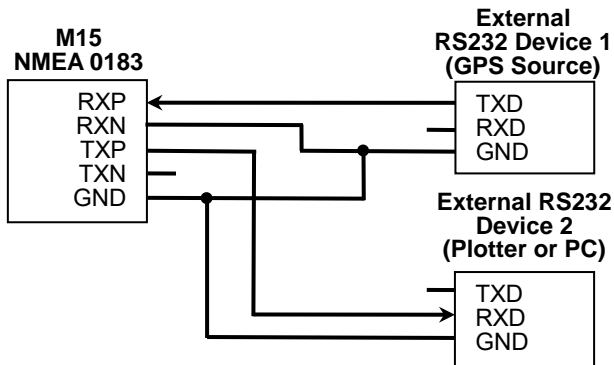

Core Colour at M15	NMEA 0183 Signal	Signal Direction (M15)	External RS-232 Devices
Brown	Data Input + (RXP)	Input	Data Output @ Device 1 (TXD)
Blue	Data Input - (RXN)	-	Ground @ Device 1 (GND)

Black	Power Ground (GND)	-	Ground @ Device 1 (GND)
Yellow	Data Output + (TXP)	Output	Data Input @ Device 2 (RXD)
Blue	Data Input – (RXN)	-	Ground @ Device 2 (GND)
Black	Power Ground (GND)	-	Ground @ Device 2 (GND)

Figure 9 NMEA0183 to RS232 Connection (Multiplexing)

When wiring NMEA 0183 to AIS-ready equipment, please refer to your equipment manual first. Smartfind M15 supports three baud rates: 4800, 9600, and 38400. The default baud rate is 38400. Use the provided McMurdo AIS configuration utility to change the baud rates (See section 3.8).

3.6 VHF Antenna Installation

The quality and positioning of the antenna is the most important factor dictating AIS performance. It is recommended that a VHF antenna with omni-directional vertical polarization and specifically tuned for AIS operation band is used. Since the range of VHF signals is largely decided by line of sight distance, AIS antenna should be placed as high as possible and at least 5 meters away from any constructions made of conductive materials.

When connecting the cable(s) with the Smartfind M15, take note of the following precautions.



DO NOT BEND CABLES

Excessive or tight bending of the cables may cause damage to the inner wires and impair overall the performance.

To avoid interference, the VHF antenna location should be placed in accordance to Figure 10.

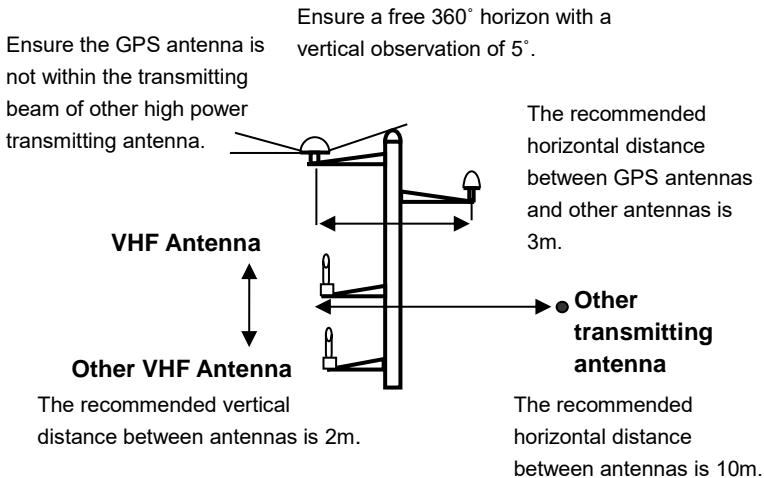

Figure 10 VHF Antenna Installation

3.7 USB Driver Installation

Your PC needs to install the USB driver in able to connect the AIS receiver. Locate the USB driver in the CD-ROM. Follow the instructions below to finish the installation.

Step 1: Open the USB CDC Driver folder and double click on USBDriverInstaller.exe to install the driver. Please click on Install Drivers to continue.

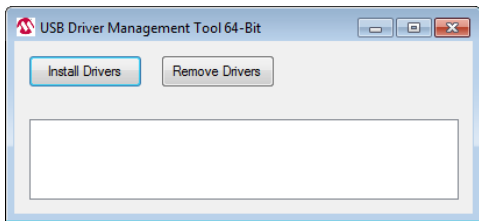

Figure 11 USB Driver Installation (1)

Step 2: A security reminder appears and asks for your confirmation.
Click Install to proceed.

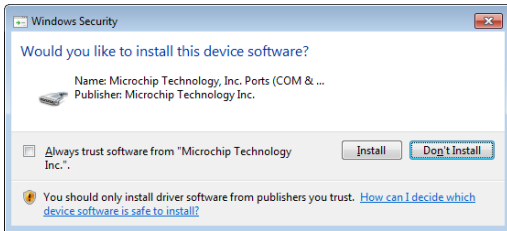

Figure 12 USB Driver Installation (2)

Step 3: Driver installation is completed. Close the window directly using the close window icon.

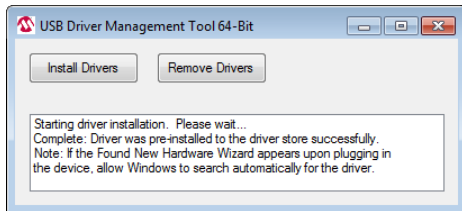

Figure 13 USB Driver Installation (3)

3.8 Smartfind M15 Configuration Software

3.8.1 Software Installation

Find the installation software McMurdo AIS Receiver Config.exe from the CD-ROM.

Step 1: Double click on the application

Step 2: You may either connect the receiver automatically or manually (see detail blow) by using the determined USB serial port number assigned by the PC.

Step 3: Accept Licence agreement, and press Next.

Step 4: Accept Product Registration, and Press Next.

Step 5: Select destination folder, and press Next.

Step 5: Select Users, and press next.

Step 6: press Finish.

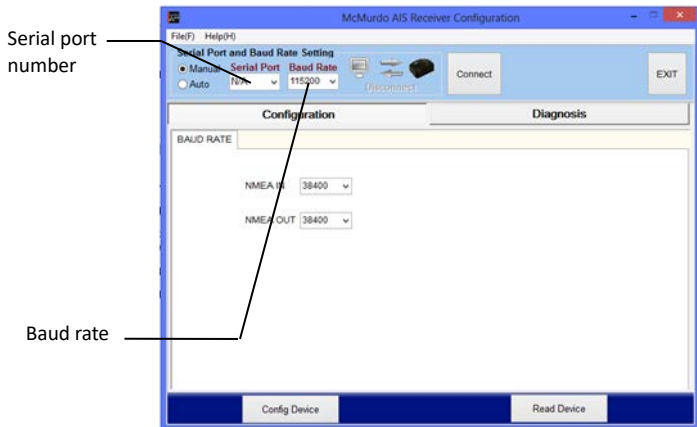

Figure 14 Software Installation (1)

To find the serial port number manually, click Start → Control Panel → Device Manager.

Expand the Ports section and look for USB Communications Port. In the sample picture below (Figure 15), the serial port number is 30.

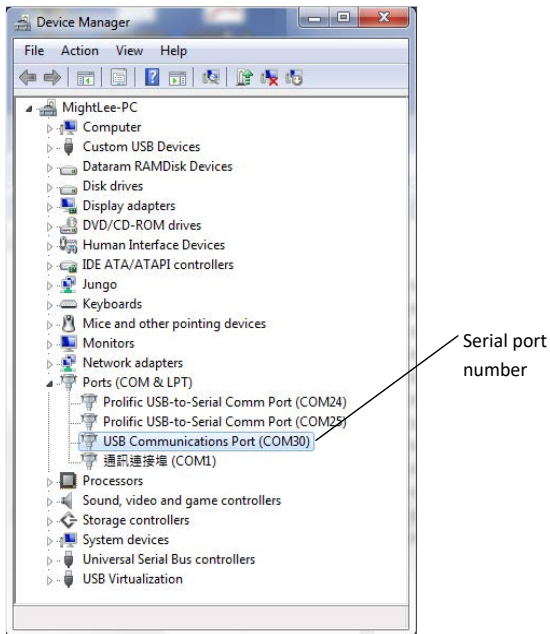

Figure 15 Software Installation (2)

Enter the value and hit “Connect” to link the computer to the receiver.

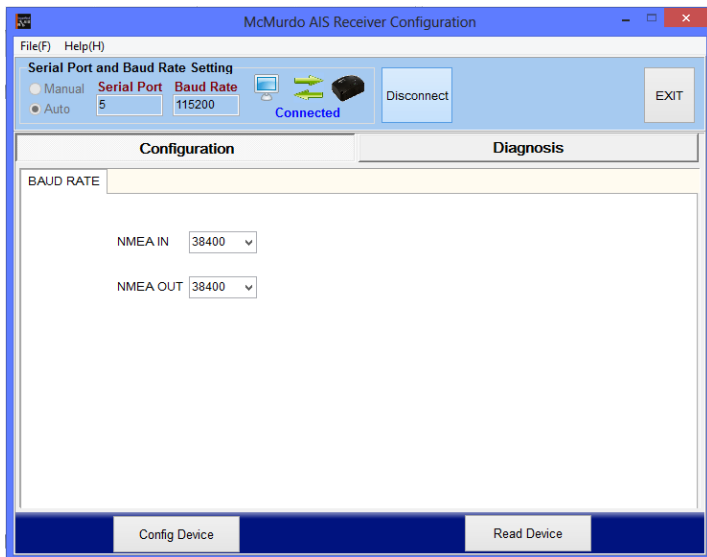

Figure 16 Software Installation (3)

3.8.2 Configuration

The Configuration tab has one submenu, Baud Rate Options.

Baud Rates:

Each Smartfind M15 model has two independent NMEA 0183 ports (In & Out) and these can have different baud rate values. To adjust the values set the desired baud rates for the NMEA input and output, and then click on “Config Device” to apply new the setting (see Figure 17).

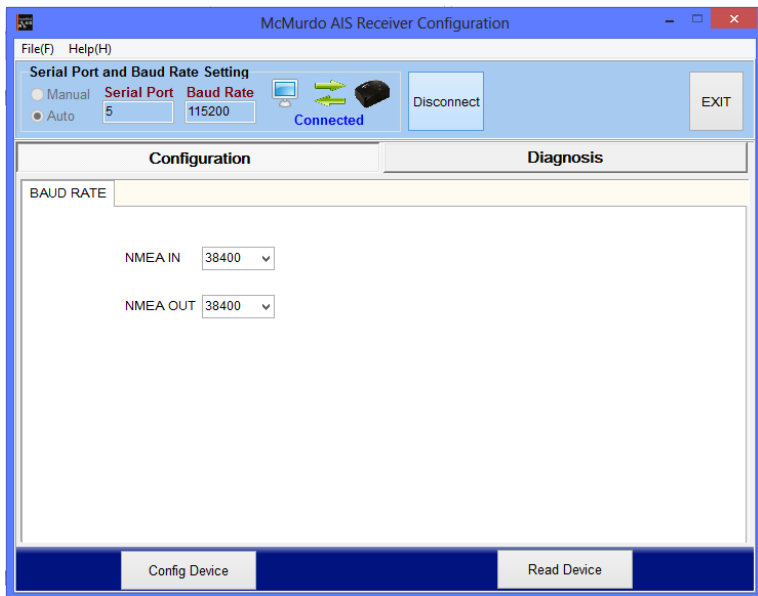

Figure 17 Baud Rates

3.8.3 Diagnosis

The Diagnosis tab has two submenus, System Check and Data Log.

System Check

System Check retrieves following information and statuses from the receiver: Firmware Version, Product Serial Number, RX position reports (see Figure 18).

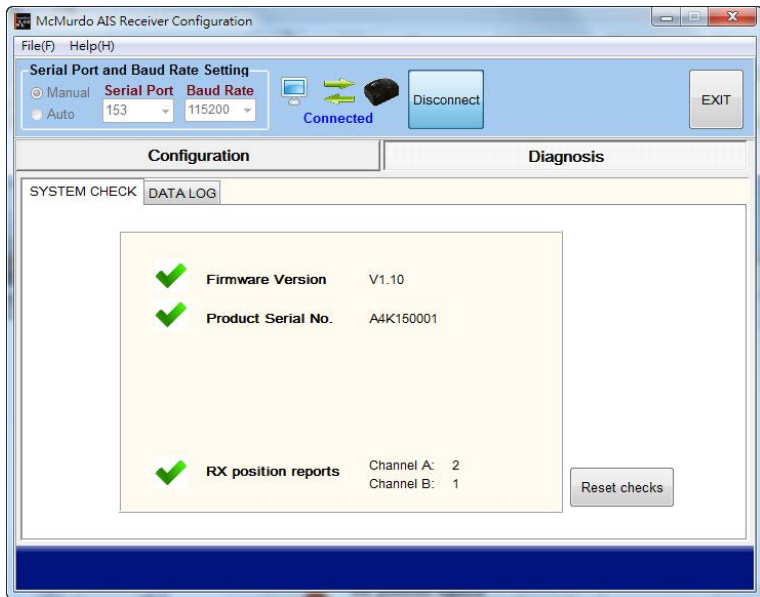

Figure 18 System Check

Data Log

The Data Log enables user to record received AIS information.

To enable or disable the recording of AIS information, use the “Enable Log” check box. Click “Save” to save the record at a preferred location on the PC connected via USB. To ensure the log is recorded the device must stay connected to the PC via USB and the Rx configurator or the McMurdo AIS viewer is running.

To clear the current listing, use the “Clear” button.

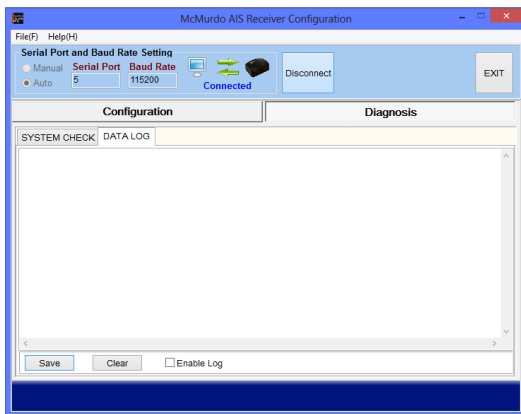

Figure 19 Data Log

3.9 NMEA 0183 Multiplexer

All Smartfind M15 models are designed with both NMEA 0183 input and output wiring.

Thus, the input and output ports support independent baud rates. For the advanced multiplexing configuration, Smartfind

M15 gets input from one NMEA 0183 device and passes to another NMEA 0183 device together with AIS information.

Smartfind M15 supports three baud rates: 4800, 9600, and 38400. The default baud rate is 38400. Use the provided configuration utility to change baud rates.

See the illustration Figure 20.

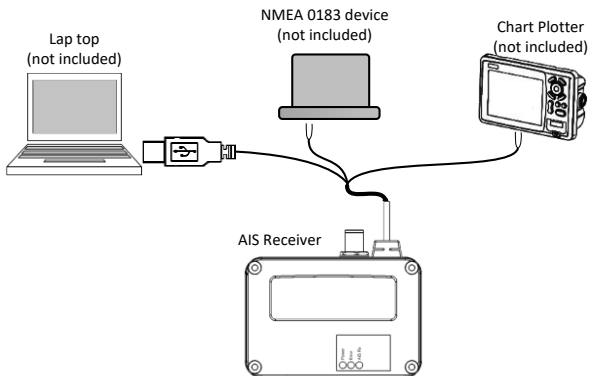

Figure 20 NMEA 0183 Multiplexer

3.10 McMurdo AIS Viewer Software

The McMurdo AIS Viewer is a supplementary application that provides a simple access for the user to view AIS information on a PC. The application provides basic features to browse the relative positions of surrounding vessels and the dynamic and static information regulated by IMO. It also enables the setting of an AIS Man Over Board list (MOB List), this enables the MMSI of any SART or MOB device to be entered along with a user name. When any of the AIS devices are activated the SRM message on the screen will display the User name from the MOB list.

For professional uses, we recommend connecting the McMurdo Smartfind M15 Series with other marine electronic products such as ECS or Radar for displaying AIS information.

The viewer (McMurdo AIS Viewer.exe) is included on the CD-ROM included in the box. A handbook detailing the viewer's operation is accessible via the help menu in the viewer.

3.11 Connecting your Receiver to Macintosh

The instruction how to connect your McMurdo AIS Receiver to your Macintosh (MAC) computer and display the received AIS Targets via OpenCPN as an example can be found on the CD attached as well as at <https://www.seasofsolutions.com> in the download area.

4 APPENDIX

4.1 Product Specifications

APPLICABLE STANDARDS	
ITU-R M.1371	IEC 60945 Ed.4.0 2002
IEC 62287-1 Ed. 2.1:2017 (applicable parts)	EN 62368-1:2014 + A11:2017
AIS RECEIVER	
Number of AIS Receivers	2 channels
CH-1	Default CH 87B (161.975MHz)
CH-2	Default CH 88B (162.025MHz)
Channel Bandwidth	25KHz
Message Format	AIS Class A & B messages
Data Rate	9,600bps / per channel
AIS Receiver Sensitivity	-107dBm
Max. Usable Sensitivity	PER \leq 20% @ -107 dBm
POWER SUPPLY	

Supply Voltage	12 / 24V DC
USB Power	5V DC / 500 mA
Power Consumption	<1.60 Watt
LED INDICATION	
CYPHO-150	Power, Error, AIS Rx
CYPHO-150S	Power, Error, AIS Rx, Radio Tx

INTERFACE	
VHF Antenna Connector	SO-239 (Female)
NMEA 0183	38400 (default), 9600, 4800 bps
USB 2.0	Supported
VHF Radio Connector (CYPHO-150S only)	SO-239 (Female)
ENVIRONMENTAL	
Operating Temperature	-15°C~55°C
Storage Temperature	-25°C~70°C
Humidity Operation	0~95% RH at 40°C

Vibration	IEC 60945
PHYSICAL	
Size in mm (w)	128 mm (4.99 inch)
Size in mm (h)	36 mm (1.40 inch)
Size in mm (d)	88 mm (3.43 inch)
Weight	210g (incl. cable)
Cable Length (power, USB, NMEA 0183)	1M
RF PERFORMANCE (CYPHO-150S only)	
Frequency Range	156.025 ~ 162.025 MHz
AIS Receiver Sensitivity	-107dBm (when not connecting to DSC)
VHF Port Insertion Loss	Receiver Path: 3.5dB Transmit Path: 1.2dB
Certification	
CE, FCC	

POWER SUPPLY	
Supply Voltage External Source	12 / 24V DC
USB	Standard USB port on PC
Power Consumption	<1.50 Watt
LED INDICATION	
Smartfind M15	Power, Error, AIS Rx
Smartfind M15S	Power, Error, AIS Rx, Radio Tx
INTERFACE	
VHF Antenna Connector	SO-239 (Female)
NMEA 0183 Input	38400 (default), 9600, 4800 bps
NMEA 0183 Output	38400 (default), 9600, 4800 bps
USB 2.0	Supported
VHF Radio (M15S only)	SO-239 (Female)
ENVIRONMENTAL	
Operating Temperature	-15°C~55°C
Storage Temperature	-25°C~70°C
Humidity Operation	0~95% RH at 40°C
Vibration	IEC 60945

Waterproof	IPX2
PHYSICAL	
Size in mm (w)	128 mm
Size in mm (h)	36 mm
Size in mm (d)	88 mm
Cable length (USB, Power, & NMEA0183)	1M
Weight	210g (incl. cable)
RF PERFORMANCE (Smartfind M15S only)	
VHF Port Insertion Loss	Receiver Path 3.5dB Transmit Path: 1.2dB
Certification	
CE, FCC	

4.2 Dimensions

Applicable to all Smartfind M15 models, (M15 shown).

Front View

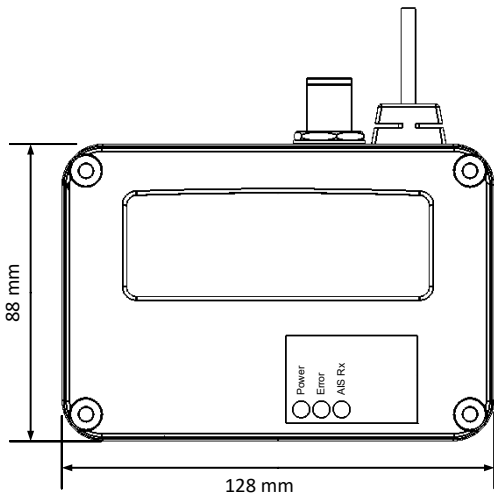

Figure 21 Front View

Side View

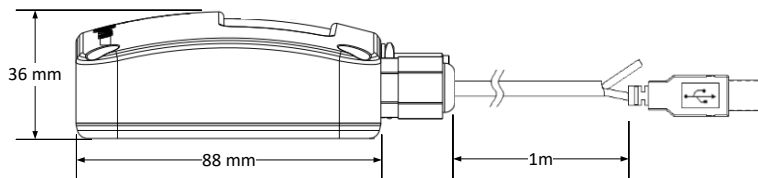

Figure 22 Side View

4.3 Accessories (Optional)

Accessories are available from Netwave Systems B.V. Contact our local dealer/agent for more details.

5 SCHEDULE OF PRODUCT WARRANTY (MCMURDO LTD)

Warranty Registration

Congratulations on purchasing your beacon. As standard, your unit has a one year (12 months) warranty from the date of purchase shown on your invoice, however, this can be extended by registering your unit on-line within 90 days of purchase at:

<https://www.seasofsolutions.com> then follow the REGISTER WARRANTY link at the top of the page.

Warranty Statement

Subject to the provisions set out below McMurdo Limited warrants that this product will be free of defects in materials and workmanship for a period of one year, for AIS products upon registration through the McMurdo Ltd warranty form, up to two years and for EPIRB and PLB upon registration through the McMurdo Ltd warranty form, up to five years (see above) from the date of purchase.

Exclusions, McMurdo will not be liable to the buyer under the above warranty:

- For any defect arising from fair wear and tear, wilful damage, negligence, abnormal working conditions, failure to

follow McMurdo's instructions (whether oral or in writing) including a failure to install properly and/or to use batteries recommended and/or supplied by McMurdo, misuse or alterations or repair of the product by persons other than McMurdo or an Approved Service Agent.

- For parts, materials or equipment not manufactured by McMurdo in respect of which the buyer shall only be entitled to the benefit of any warranty or guarantee given by the manufacturer to McMurdo. For the battery storage life which is specifically excluded from this warranty.
- If the total price for the product has not been paid.
- Warranty is not transferable.
- Batteries.

THE LIMITED WARRANTY STATED ABOVE IS EXCLUSIVE AND IN LIEU OF ANY OTHER WARRANTY, EXPRESS OR IMPLIED, INCLUDING BUT NOT LIMITED TO ANY IMPLIED WARRANTY OF MERCHANTABILITY OR FITNESS FOR A PARTICULAR PURPOSE.

McMurdo will not be liable for indirect, special, incidental or consequential damages of any kind sustained from any cause. In no event shall McMurdo be liable for any breach of warranty or other claim in an amount exceeding the purchase price of the product. This warranty does not affect any statutory rights of the consumer. In order to be valid, claims must be made under the

above warranty in writing as soon as practicable after discovery of the defect or failure and within the warranty period referred to above. Proof of purchase will be required. The claim should be sent together with the product in question to the address set out below or to an Approved Service Agent. Following a valid warranty claim McMurdo shall be entitled to repair or replace the product (or part) in question free of charge, or at McMurdo's sole discretion to refund to the buyer the price of the product (or a proportional part of the price). McMurdo shall not be liable to a buyer who is not a consumer for any other loss or damage (whether indirect, special or consequential loss of profit or otherwise) costs, expenses or other claims for compensation which arise out of or in connection with this product. In the case of a consumer, McMurdo shall only be liable where other loss or damage is foreseeable. Nothing shall limit McMurdo's liability for death or personal injury caused by its negligence. This warranty is to be interpreted under English law.

All enquiries relating to this warranty or Approved Service Agents should be sent to McMurdo Ltd

Phone: +44 (0)23 9262 3900

Email: sales@seasofsolutions.com

Website: www.seasofsolutions.com

6 ACRONYMS

AIS	Automatic Identification System
COG	Course Over Ground
CPA	Distance to Closest Point of Approach
CSTDMA	Carrier-sense time division multiple access
DSC	Digital Selective Calling
ECS	Electronic Chart System
ETA	Estimated Time of Arrival
GPS	Global Positioning System
IMO	International Maritime Organization
MMSI	Maritime Mobile Service Identity
SOG	Speed Over Ground
SRM	Safety Related Message
TCPA	Time to Closest Point of Approach
TDMA	Time Division Multiple Access
UTC	Coordinated Universal Time
VHF	Very High Frequency
VTS	Vessel Traffic Service

21-335-001 Issue 10

Netwave Systems B.V.

Blauw-roodlaan 100,
2718 SJ Zoetermeer,
Netherlands

Phone: +31 (0) 8811 81500

Email: customer.service@seasofsolutions.com

Website: www.seasofsolutions.com/

21-335-001 Issue 10

A Seas Of Solutions Business