

Seldén Sail hardware

OWS sliders and Batten receptacles



3.5 OWS (Outer Wheel Support) slider

Seldén OWS sliders are designed both as batten sliders and webbing sliders. Each model is available in 5 different versions. One version fits Seldén E-sections (1977-2002) and older Seldén/Kemp oval sections. Any of the other 4 versions fits most of all other mast brands on the market.

OWS sliders do not fit Seldén C-section for which MDS-sliders should be used.

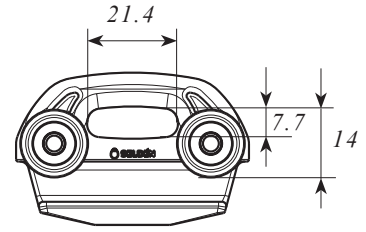

OWS slider for webbing

To achieve maximum strength, the OWS slider should be attached to the main sail using a webbing strap.

All sliders for webbing can be used for headboard attachments and as intermediate sliders.

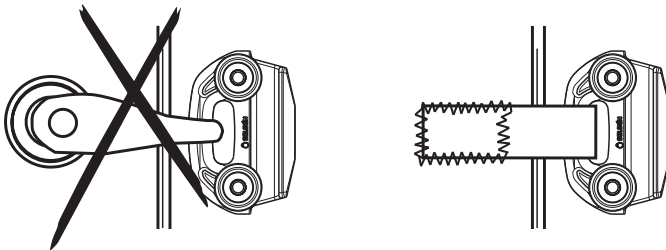
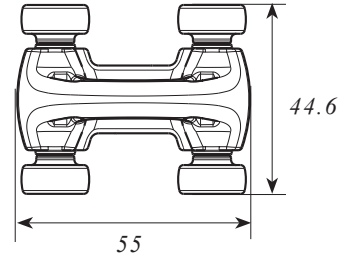

OWS slider for batten

The OWS batten slider is designed to take compression load from the batten in a full batten main sail. To achieve optimal function and strength, use Seldén toggle M10 stud 511-739-01.

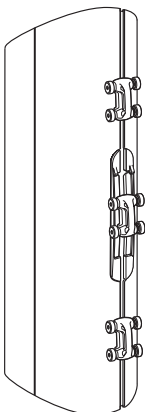
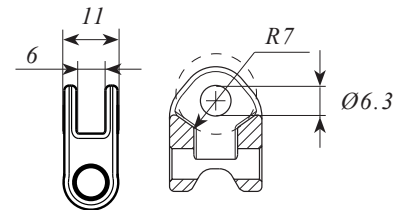
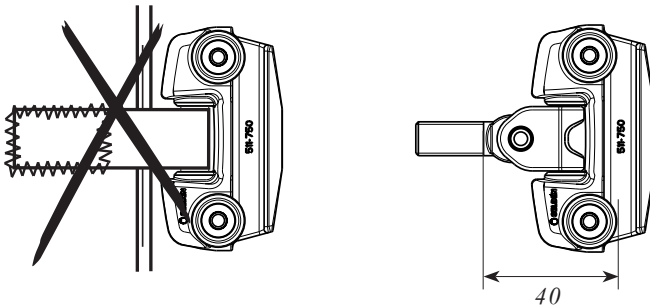
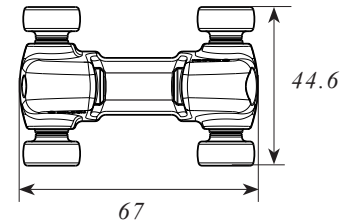
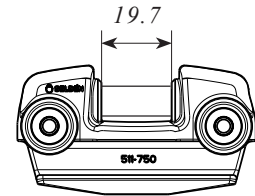

OWS compatible sail feeder gates

The OWS E-section slider (511-740 and 511-750) can be used with, and **passes through** Seldén sail feeder gate 505-501-01.





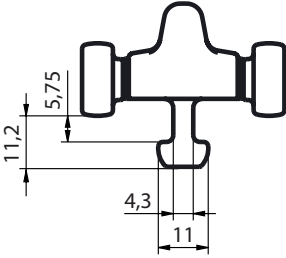
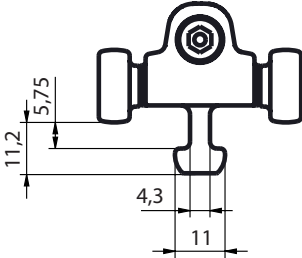
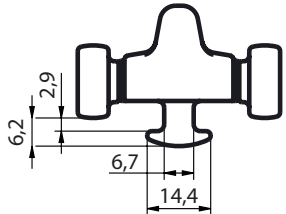
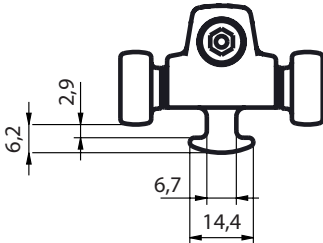
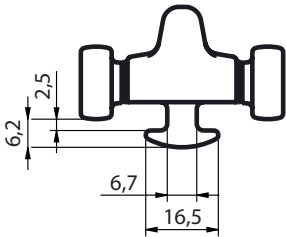
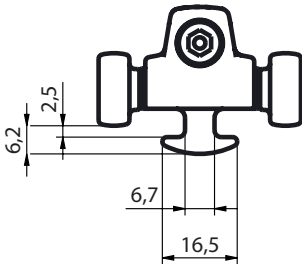
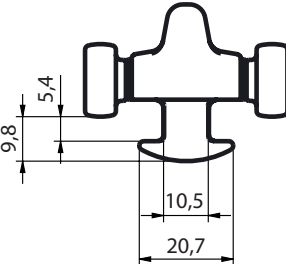
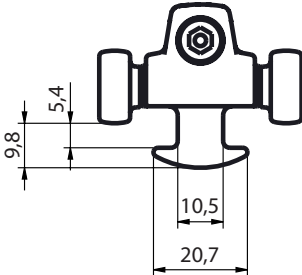
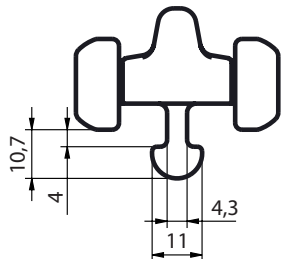
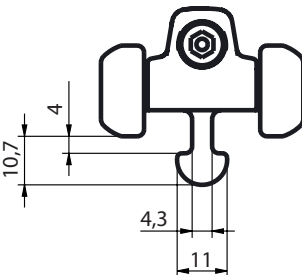























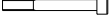



















The OWS sliders 511-744 and 511-754 for keelboat sections (C106-C139) can be used with and passes through Seldén sail feeder gate 505-533-02.











3.5.1 OWS slider dimensions

Type	Measurements (mm)	Type	Measurements (mm)
OWS slider webbing 511-740		OWS slider batten 511-750	
OWS slider webbing 511-741		OWS slider batten 511-751	
OWS slider webbing 511-742		OWS slider batten 511-752	
OWS slider webbing 511-743 1)		OWS slider batten 511-753 1)	
OWS slider webbing 511-744		OWS slider batten 511-754	

All sliders for webbing can be used for headboard attachments and as intermediate sliders.

1) OWS sliders do not fit Seldén C-section for which MDS-sliders should be used.

Type	Art. No.	Fits luff groove (mm)	Breaking load (N)	Assembly Art. No.	Parts Art. No.		
OWS slider webbing	 511-740	5.5	5000	 511-740-01			
OWS slider batten	 511-750	5.5	7000	 511-750-03	 511-750-01	 511-739-01 M10 screw	 153-117
				 511-750-02	 511-750-01		 153-117
OWS slider webbing	 511-741	10	5000	 511-741-01			
OWS slider batten	 511-751	10	7000	 511-751-03	 511-751-01	 511-739-01 M10 screw	 153-117
				 511-751-02	 511-751-01		 153-117
OWS slider webbing	 511-742	10	5000	 511-742-01			
OWS slider batten	 511-752	10	7000	 511-752-03	 511-752-01	 511-739-01 M10 screw	 153-117
				 511-752-02	 511-752-01		 153-117
OWS slider webbing	 511-743	12	5000	 511-743-01			
OWS slider batten	 511-753	12	7000	 511-753-03	 511-753-01	 511-739-01 M10 screw	 153-117
				 511-753-02	 511-753-01		 153-117
OWS slider webbing Big wheel	 511-744	5.5	5000	 511-744-01			
OWS slider batten Big wheel	 511-754	5.5	7000	 511-754-03	 511-754-01	 511-739-01 M10 screw	 153-117
				 511-754-02	 511-754-01		 153-117

Type	Fits mast section (only geometric fit)						
OWS slider webbing 511-740 	Seldén			John Mast	Soromap	Sparcraft	Z-spars
	E-section (10° aft face)	E-section (round aft face)	D-section	135D 148D 150D 165D 167D 185D 186D 208D 222D 245D 280D 305D 335D	NF200 NF270 NF350 NF430 NF540 NF710 NF1410	F135 F195 F305 F385 F460 I620 S622 I830 S830	Z301 Z351 Z380 Z401 Z501 Z531 Z601 Z602 Z701 Z702
OWS slider batten 511-750 	138/95 155/104 170/115 177/124 189/132 206/139 224/150 237/162 274/185	147/95 162/104 178/115 216/139 239/162	129/100 137/113 146/112 160/132				
OWS slider webbing 511-741  OWS slider batten 511-751 							
OWS slider webbing 511-742  OWS slider batten 511-752 							
OWS slider webbing 511-743  OWS slider batten 511-753 				220E 262E 290E		NG60 NG70 NG80 NG86 F580 F740 F1060 F1395 S1630 S2100 F2390 F3360 F4600	Z902 Z1001 Z1250 Z1400
OWS slider webbing Big wheel 511-744  OWS slider batten Big wheel 511-754 	C-section C106 C116 C126 C139			150E 116E 125E		F35 F50 F67 F78 F101 S137 S180 S260 S330 IMS80 IMS256	Z170 Z190 Z230 Z265

Batten receptacles

Each size of the adjustable batten receptacles is available in two models to ensure correct fit on round, flat and rectangular battens.

Safety cord secures the cover to the body.

The FA-models have access to the adjustment screw both front and rear which enables adjustment of the batten even when the sail is flaked on the boom. The adjustment screw is compatible with multiple screw heads.

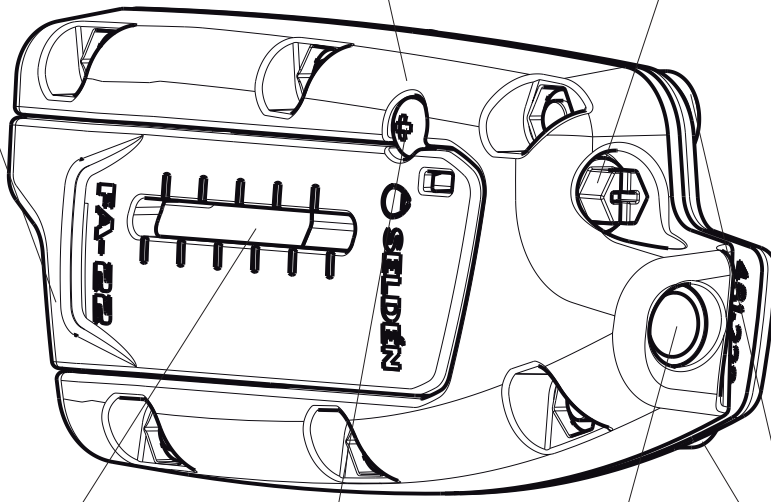

M10 thread.

Indicators to record batten tension for the ultimate trim.

Easy set up and removal of batten with sliding cover and a locking screw. No need to fully release the screw to remove the cover.

Protecting collar at the backing plate prevents the forward screw heads to chafe on the mast surface.

Batten receptacle fitting

The fittings are designed to be used with toggle M10 stud (511-712-01, 511-727-02 or 511-739-01).

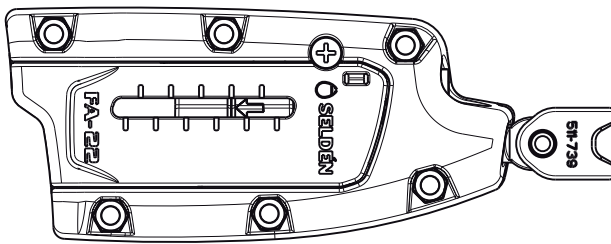

The adjustable batten receptacles are available for either round or rectangular battens.

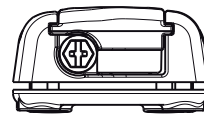



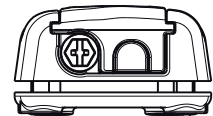





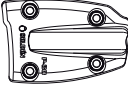

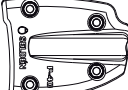

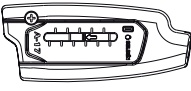

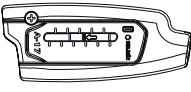
461-210-01

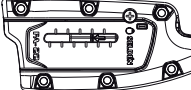

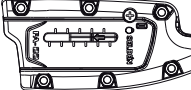
461-210-02

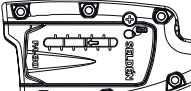
Batten receptacle range

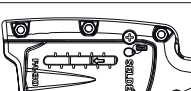
Type	Art. No.	Batten sizes (mm)		Batten receptacle		Adj. length (mm)	Stud dim.
		Round	Flat				
P-30	461-237-01	Ø10	5.5x31			-	M10
P-40	461-235-01	Ø10	5.5x41			-	M10
A-17	461-210-01	-	6.5x18			38	M10
	461-210-02	Ø8	-				
FA-22	461-220-01	-	9.5x23			33	M10
	461-220-02	Ø10	-				
FA-30	461-230-01	-	6.5x31			36	M10
	461-230-02	Ø12	-				

DINGHIESKEELBOATSYACHTS

Seldén Mast AB, Sweden
Tel +46 (0)31 69 69 00
Fax +46 (0)31 29 71 37
e-mail info@seldenmast.com

Seldén Mast Limited, UK
Tel +44 (0) 1329 504000
Fax +44 (0) 1329 504049
e-mail info@seldenmast.co.uk

Seldén Mast Inc., USA
Tel +1 843-760-6278
Fax +1 843-760-1220
e-mail info@seldenus.com

Seldén Mast A/S, DK
Tel +45 39 18 44 00
Fax +45 39 27 17 00
e-mail info@seldenmast.dk

Seldén Mid Europe B.V., NL
Tel +31 (0) 111-698 120
Fax +31 (0) 111-698 130
e-mail info@seldenmast.nl

Seldén Mast SAS, FR
Tel +33 (0) 251 362 110
Fax +33 (0) 251 362 185
e-mail info@seldenmast.fr

**Seldén Mast Asia Ltd,
Hong Kong**
Tel +852 3572 0613
Fax +852 3572 0623
e-mail info@seldenmast.com.hk

www.seldenmast.com

Dealer:

The Seldén Group is the world's leading manufacturer of masts and rigging systems in carbon and aluminium for dinghies, keelboats and yachts. The Group consists of Seldén Mast AB in Sweden, Seldén Mast A/S in Denmark, Seldén Mast Ltd in the UK, Seldén Mid Europe B.V. in the Netherlands, Seldén Mast SAS in France and Seldén Mast Inc in the USA. Our well known brands are Seldén and Furlex. The worldwide success of Furlex has enabled us to build a network of over 750 authorised dealers covering the world's marine markets. So wherever you sail, you can be sure of fast access to our service, spare parts and know-how.

SELDÉN and FURLEX are registered trademarks of Seldén Mast AB

