

Sailmaker's guide

Everything a sailmaker needs to know about
Seldén masts, booms and furling systems.

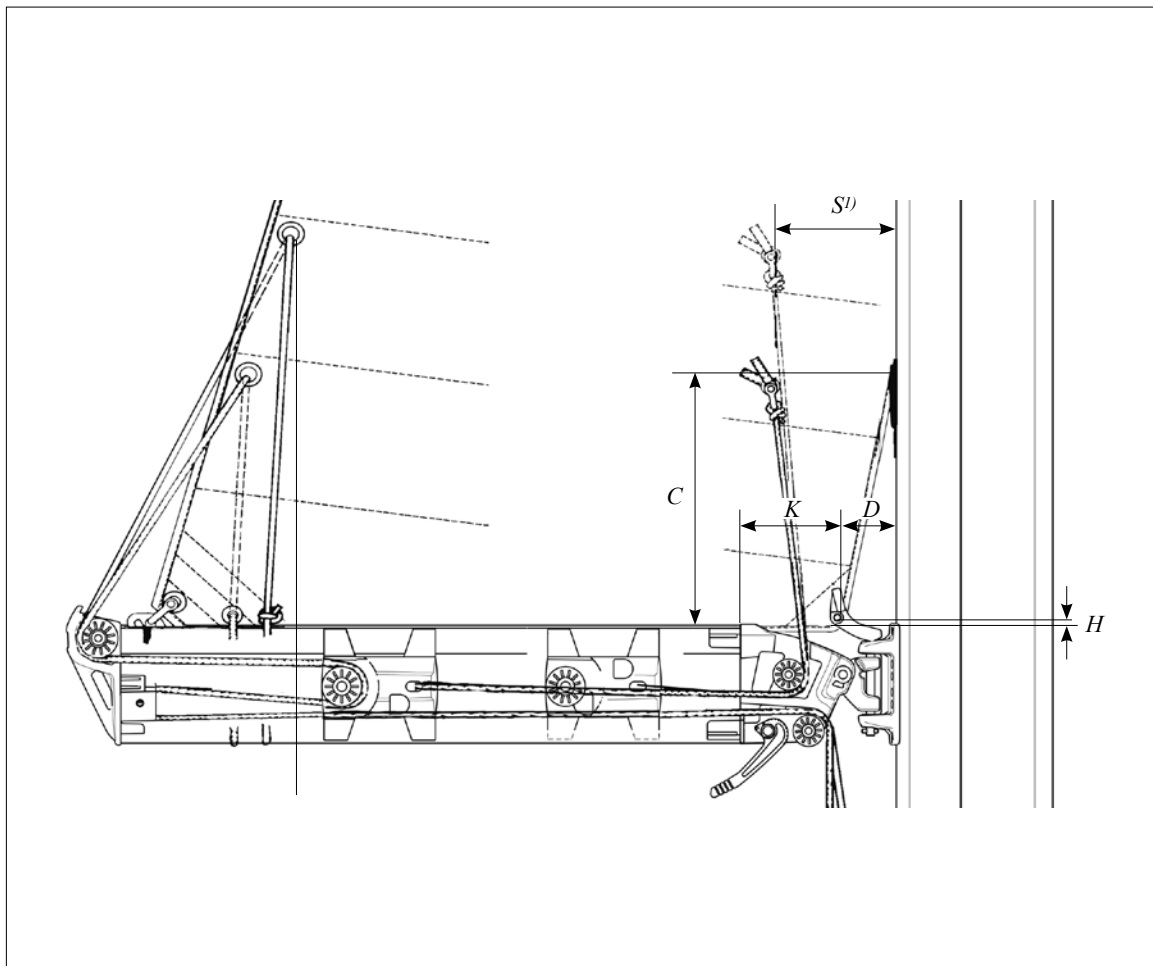

1 Introduction

This guide is intended to provide sailmakers with the information necessary for them to ensure that rig and sail will be compatible. It covers the major part of Seldén's production from 1977 onwards. The information generally applies to Kemp products of the same period.

Masts between 1977 and 2002 are normally type D or E (conventional masts) or type R (furling mast). Masts from 2003 are type C (conventional masts) or type F (furling masts). With the introduction of new C- and F masts from 2017, these masts are now denoted C (2003), C (2017), F (2003), F (2017). Each section of the guide is marked with mast type to help the reader in locating the correct information.

D D and E-sections: Conventional masts, 1977 - 2002

R R-sections: Furling masts, 1989 - 2002

C C-sections: Conventional masts, 2003 → & 2017 →

F F-sections: Furling masts, 2003 → & 2017 →

Although this Guide is primarily aimed at Sailmakers, the content should assist our end customers in making the best use of our improved product.

However, we would point out that this guide is only intended as an aid, and that variations can occur. It is the sailmaker's responsibility to ensure that the sail suits the rig.

This information will be up-dated as new products are introduced. Seldén reserves the right to change the specifications given without prior notice.

		The following information must be given to the sailmaker by the customer:
Mainsails	Conventional mainsail with "short" battens.	• Mast section dimensions. • Boom section dimensions. • Sail Plan ("P" & "E").
	Conventional mainsail with full length battens.	• Mast section dimensions. • Boom section dimensions. • Sail Plan ("P" & "E").
	Furling mast mainsails	• Mast section dimensions. • Boom section dimensions. • Reefing system type (Seldén furling, Furlex-Main, etc.)
Foresails	Roller furling genoas.	• Furlex type. • Total forestay length incl. all toggles or available sail space • Sail Plan

Contents

	<i>Page</i>		<i>Page</i>
1		Introduction	2
2		Conventional masts	4
2.1		<i>Mast sections</i>	4
2.2		<i>Mast deflection curves</i>	5
2.3		<i>Head measurements, Yacht masts</i>	6
2.4		<i>Head measurements, Keelboat</i>	7
3		Mainsails	8
3.1		<i>Fitting slides</i>	8
3.2		<i>Sail slides E-masts</i>	8
3.3		<i>Sail slides C-masts</i>	9
3.4		<i>Shackles for sliders</i>	9
3.5		<i>OWS slider for webbing</i>	10
3.5.1		<i>OWS slider - dimension</i>	11
3.5.2		<i>OWS slider - range</i>	12
3.6		<i>MDS Full batten system for C-masts</i>	14
3.6.1		<i>MDS 45 and 68 Full batten system</i>	14
3.6.2		<i>Parts and RM-limits, MDS 45 and 68</i>	15
3.6.3		<i>IWS Full batten system for C-masts</i>	16
3.6.4		<i>Parts and RM-limits, IWS 45, C137, C153, C180</i>	17
3.6.5		<i>IWS Full batten system for C-masts, C192, C225, C242, C261, C280 (2017-)</i>	18
3.6.6		<i>Parts and RM-limits, IWS 45, IWS 68 Masts C192, C225, C242, C261, C280</i>	19
3.6.7		<i>MDS 80 Full batten system</i>	20
3.6.8		<i>Parts and RM-limits, MDS 80</i>	21
3.7		<i>Seldén – RCB full batten System 22 and System 30</i>	22
3.7.1		<i>Dimensions</i>	22
3.7.2		<i>Parts</i>	23
3.7.3		<i>Try Sail slider</i>	23
3.8		<i>Sail feeder gates</i>	24
3.8.1		<i>Seldén E-section Sail feeder gate</i>	24
3.8.2		<i>Seldén MDS sail feeder gate - Yacht mast</i>	25
3.8.3		<i>Seldén IWS Sail feeder gate - Yacht masts</i>	26
3.8.4		<i>Seldén feeder gate - Keelboat</i>	27
4		Batten Receptacles	28
4.1		<i>Batten receptacle fitting</i>	29
4.2		<i>Batten receptacle range</i>	29
5		Booms and reef systems	30
5.1		<i>Boom sections on conventional masts (through 1991)</i>	31
5.2		<i>Traditional slab-reefing booms from 1991 inclusive 2003</i>	32
5.3		<i>Traditional slab-reefing booms on C-mast from 2003 - 2007</i>	33
5.4		<i>Traditional slab-reefing booms on C-mast from 2008</i>	34
5.5		<i>Single line reef booms from 1991 - 2003</i>	35
5.6		<i>Single line reef booms on C-mast from 2003 - 2007</i>	36
5.7		<i>Single line reef booms on C-mast from 2008</i>	37
5.8		<i>Slab reef Match booms</i>	38
5.9		<i>Single line reef Match booms</i>	39
5.10		<i>Clews</i>	40
5.11		<i>Running reef-hooks</i>	41
5.12		<i>Boom sliders - eye</i>	42
6		Furling mast	43
6.1		<i>R section: manual, hydraulic and electro</i>	43
6.2		<i>F section: manual, hydraulic and electro</i>	45
6.3		<i>Furlex Main - Retro-fit system</i>	49
6.4		<i>Design aspects of furling mast main sails</i>	51
7		Furlex - Seldén jib furling and reefing system	52
7.1		<i>Furlex 20S-40S</i>	52
7.2		<i>Furlex 50S-500S</i>	53
7.3		<i>Furlex 104S-404S</i>	54
7.4		<i>Furlex 200TD-400TD (Trough Deck)</i>	55
7.5		<i>Furlex 204TD-404TD (Trough Deck)</i>	56
7.6		<i>Furlex Hydraulic 300H-500H</i>	57
8		Furling system CX & GX	58
8.1		<i>Seldén CX</i>	58
8.2		<i>Seldén GX</i>	59

D & E 2 Conventional masts

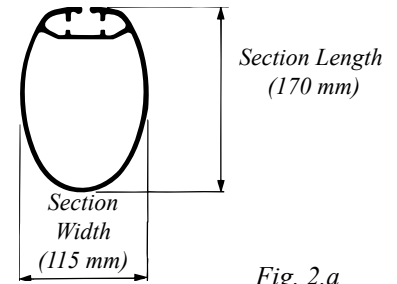
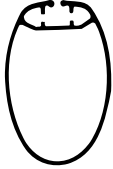





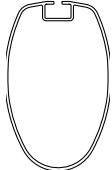



Fig. 2.a

C 2.1 Mast sections

Mast section measurements are given as follows:

Section Length/Section Width (i.e. 170/115). Take note of the mast section shape. This will help identification and the use of correct measurements. The Section Length of the mast can usually be found in the number engraved at the mast heel. For example K23-170-1233.

Conventional masts before 2003				Conventional masts from 2003							
	Mast	Luff Groove mm	Slider		Mast	Mast dim	Luff groove mm	Groove insert for bolt rope ¹⁾	MDS-car	Sail slider	Bolt rope (mm)
E-Section (10° aft face) 	122/85 130/93	4.0 + 1.0 - 0.0	511-601	C-Section (2006) 	C080 C086 C096	79/60 87/64 96/69	4.5 ± 0.75	-	-	511-601	Ø 10
	138/95 155/104 170/115 177/124 189/132 206/139 224/150 237/162 274/185	5.5 ± 0.75	511-602 or 511-603		C106 C116 C126 C139	106/71 116/75 126/79 139/85	5.0 ± 0.75	-	-	511-602	Ø 10
	321/171 365/194	6.25 ± 0.75	511-603		C-Section (2003) 	C156 C175 C193	156/87 175/93 193/102	10 ± 0.75	5.5 ± 0.75	511-702	511-605 or 511-607
E-Section (Round aft face) 	126/85	4.0 + 1.0 - 0.0	511-601	C211 C227 C245 C264 C285 C304		211/110 227/119 245/127 264/136 285/147 304/157	10 ± 0.75	5.5 ± 0.75	511-701 or 511-702	511-605 or 511-607	Ø 10
	147/95 162/104 178/115 216/139 239/162	5.5 ± 0.75	511-602 or 511-603	D-Section 		C321 C365	321/171 365/194	16 ± 0.75	-	511-730 or 511-731	-
D-Section 	109/88 121/92	4.0 + 1.0 - 0.0	511-601		C section (2017) 	C137 C153 C180 C192 C208 C225 C242 C261 C280	137/98 153/107 180/113 192/120 208/131 225/141 242/153 261/164 280/176	10.5 + 0.7	4.7 + 0.5	511-729 or 511-760	511-605 or 511-607
	129/100 137/113 146/112 160/132	5.5 ± 0.75	511-602 or 511-603	C137 C153 C180 C192 C208 C225 C242 C261 C280		137/98 153/107 180/113 192/120 208/131 225/141 242/153 261/164 280/176	10.5 + 0.7	4.7 + 0.5	511-729 or 511-760	511-605 or 511-607	Ø8-Ø10 Ø8-Ø10 Ø8-Ø10 Ø8-Ø10 Ø8-Ø10 Ø8-Ø10 Ø8-Ø10 Ø8-Ø10
P-Section 	73/53 90/65 100/73 111/81 123/90	4.0 + 0.75 - 0.00	611-601								
	137/100	4.5 + 0.75 - 0.00	511-601								
	152/111 169/123 188/137	5.5 ± 0.75	511-601 or 511-603								

¹⁾ Special groove insert and sail feeder gate are required to accept bolt rope. If sail slider are to be used in combination with bolt rope insert, use HA 258/A019 or Rutgerson 102.

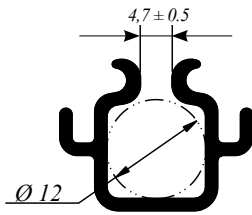
C**Groove insert for bolt rope****C (2003) size C156-C304**

Recommended bolt rope: Ø10mm

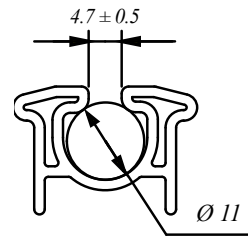
C (2017) size C137-C280

Recommended bolt rope: Ø8mm

E & C**2.2 Mast deflection curves**

Our spars and fittings are designed to cope with a maximum longitudinal deflection of 2% of the fore-triangle height (FH). On fractional rigs the maximum deflection can be taken as being 2% of the mainsail luff (P). These values are guiding principles only.

The conditions are:

- 1) The mast forms an even curve (convex front) from deck level to mast-head.
- 2) The deflection must be kept within the stated values, even in rough seas, by suitable longitudinal staying.

The deflection curve is formed by:

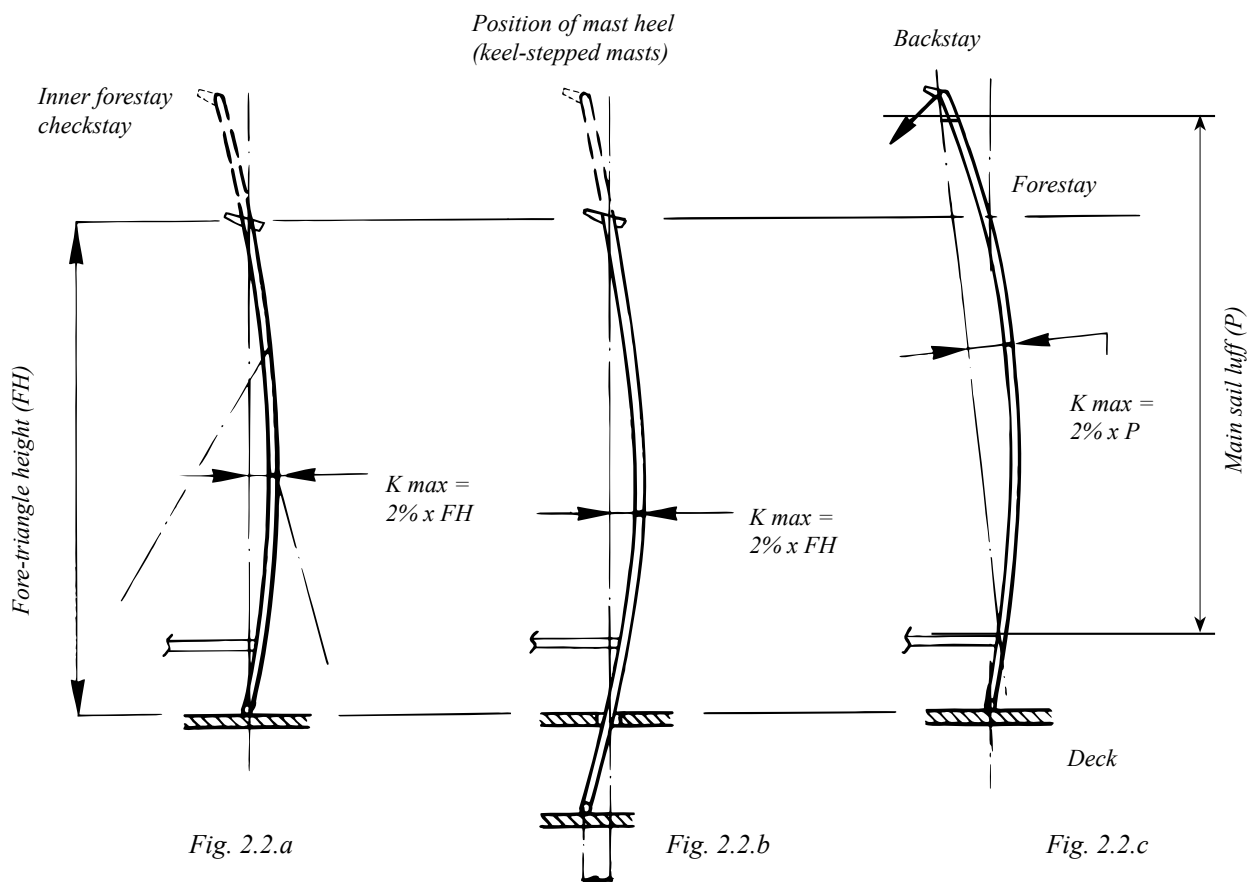

It may be possible to increase the above values on some masts. However, in such cases the customer must request a special calculation for this from Seldén Mast, and have our written agreement for the increase in deflection depth.

2.3 Head measurements, Yacht masts

See page 43-50 for furling mast and page 49-50 for Furlex Main - Retro-fit system.

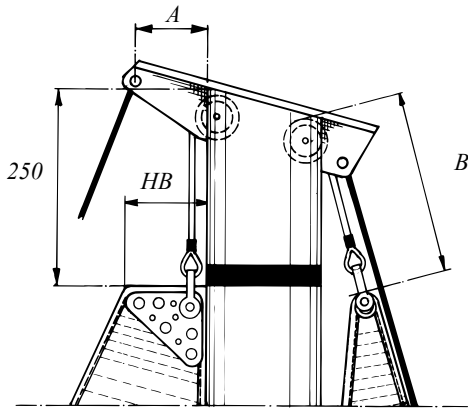

Fig. 2.3.a

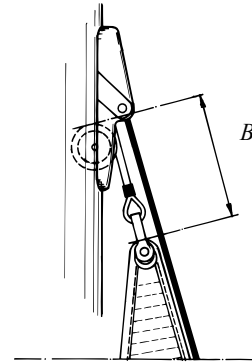

Fig. 2.3.b

A (mm)				
C-mast			E-mast	
	Mast-head	Fractional std/long crane	Tapered std/long crane	
C156	70	80/280	80/270	"A" = 75-100 mm. (With non-tapered fractional rigs using section D-109/88 or E-122/85 the measurement is 25 mm)
C175	105	115/280	85/295	
C193	100	100/265	75/200	
C211	110	115/235	105/240	
C227	110	100/220	90/225	
C245	115	120/285	110/210	
C264	110	100/265	65/95	
C285	100	130	90/120	
C304	175	110	80/110	
C321	175	140/190	110	
C365	240	155	110	

To avoid the halyard splice or Talurit damaging the mast-head sheave, dimension "B" must not be shorter than that shown.

When choosing the "B" measurement, consideration must be taken to dimension HB and the mainsail roach in relation to the backstay.

For other halyard boxes the "B" measurement is calculated from the upper edge of the sheave to the topmost point of the sail.

Rope halyard			Wire halyard		
Rope Dimension	"B" mm Knot	"B" mm Spliced	Halyard Wire Dimension	"B" mm Hand-Spliced Halyard Eye	"B" mm Talurit-Spliced Halyard Eye
Ø 6 mm	60	430	Ø 3 mm	200	140
Ø 8 mm	70	430	Ø 4 mm	230	150
Ø 10 mm	80	430	Ø 5 mm	260	170
Ø 12 mm	90	440	Ø 6 mm	300	200
Ø 14 mm	100	440	Ø 7 mm	350	230
			Ø 8 mm	400	250

C

2.4 Head measurements, keelboat

See page 43-48 for furling mast and page 49-50 for Furlex Main - Retro-fit system.

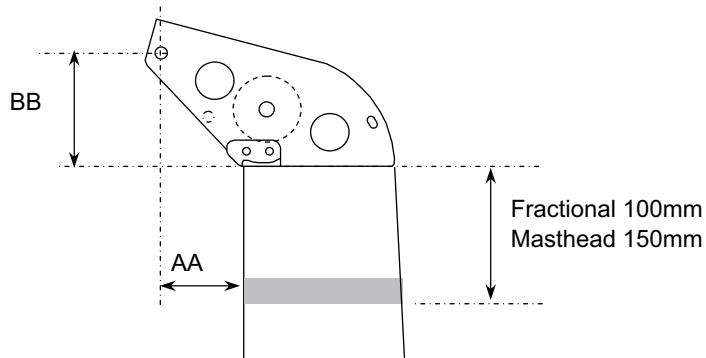

Fig. 2.4.a

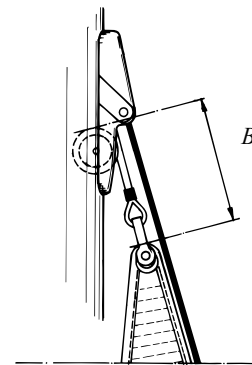

Fig. 2.4.b

Section	Masthead		Fractional						
	AA	Non tapered mast		Tapered mast					
		AA	BB	Standard crane		Long crane		Top with spin block	
	AA	BB	AA	BB	AA	BB	AA	BB	
C087	-	65	75	58	65	149	90	99	75
C096	-	56	75	52	65	143	90	93	75
C106	-	80	85	70	70	180	100	105	80
C116	-	70	85	63	70	173	100	99	80
C126	70	95	90	83	85	212	120	127	100
C139	65	82	90	74	85	203	120	118	100

Rope halyard		
Rope Dimension	"B" mm Knot	"B" mm Spliced
Ø 5 mm	60	430
Ø 6 mm	60	430
Ø 8 mm	70	430
Ø 10 mm	80	430
Ø 12 mm	90	440
Ø 14 mm	100	440

To avoid the halyard splice or Talurit damaging the mast-head sheave, dimension "B" must not be shorter than that shown.

For other halyard boxes the "B" measurement is calculated from the upper edge of the sheave to the topmost point of the sail.

D&E

3 Mainsails

C

3.1 Fitting slides

To avoid jamming in the luff groove, slides must have freedom of movement on the sail.

Fig. 3.1.a

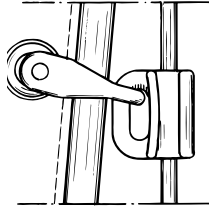

Correct: Free-moving fixture

Fig. 3.1.b

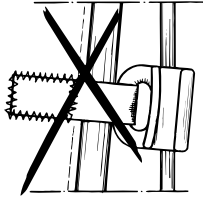

Wrong: Stiff fixture

Several systems are available for full length battens. Seldén's different systems (RCB, MDS, OWS & IWS) are presented in this guide. Refer to the relevant manufacturers concerning other systems.

D&E

3.2 Sail slides E-masts

It is imperative that the correct sliders are used on Seldén masts in order to fit the Seldén sail feeder gate.

Art. no.	Slider (mm)	Fits luff groove (mm)	Breaking load	Bainbridge part no.
511-601		4	700 N (70Kp)	A 013
511-602		5	2250 N (225Kp)	A 014
511-603		5.5	4000 N (400 Kp)	A 015

C

3.3 Sail slides C-masts

It is imperative that Seldén slides are used on Seldén masts in order to fit the Seldén sail feeder gate.

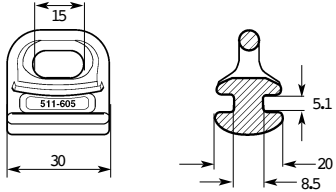
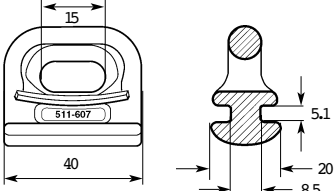
Art. no.	Slider (mm)	Fits luff groove (mm)	Breaking load (N)	Bainbridge part no.
511-605		10	2250 N (225 Kp)	A011
511-607		10	4000 N (400 Kp)	A012

1) For Mast sections, see page 11 and 13.

D & E

3.4 Shackles for sliders

C

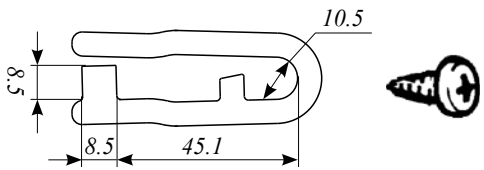
Art. no.	Shackle (mm)	Fits slide (mm)	Breaking load (N)	Bainbridge part no.
307-094-01		511-602 511-603 511-605 511-607	2000N (200 Kp)	-



Important!
The shackle should not to be used with MDS cars.

D & E

3.5 OWS (Outer Wheel Support) slider

+Other brands

Seldén OWS sliders are designed both as batten sliders and webbing sliders. Each model is available in 5 different versions. One version fits Seldén E-sections (1977-2002) and older Seldén/Kemp oval sections. Any of the other 4 versions fits most of all other mast brands on the market.

OWS sliders do not fit Seldén C-section for which MDS-sliders should be used.

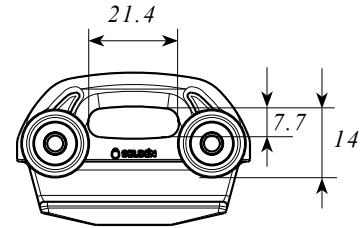

OWS slider for webbing

To achieve maximum strength, the OWS slider should be attached to the main sail using a webbing strap.

All sliders for webbing can be used for headboard attachments and as intermediate sliders.

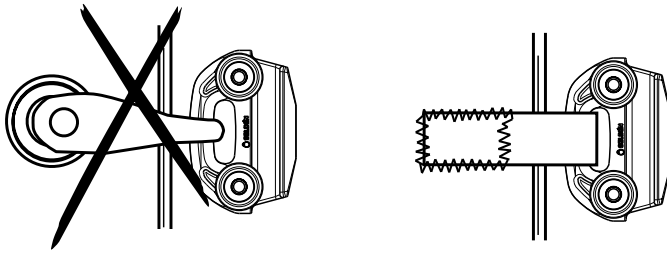
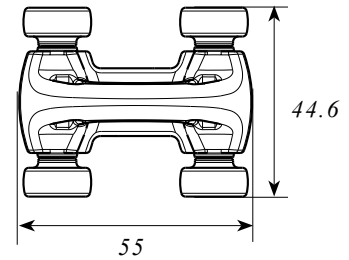

OWS slider for batten

The OWS batten slider is designed to take compression load from the batten in a full batten main sail. To achieve optimal function and strength, use Seldén toggle M10 stud 511-739-01.

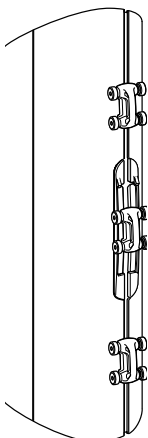
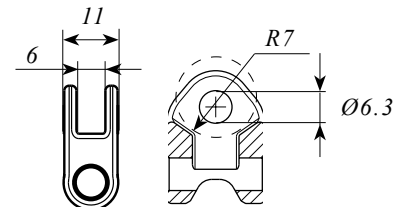
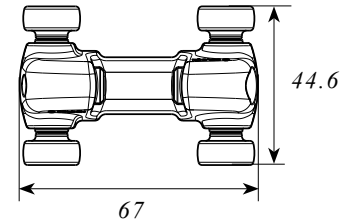
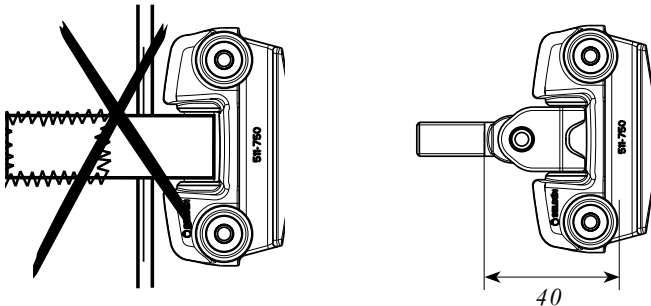
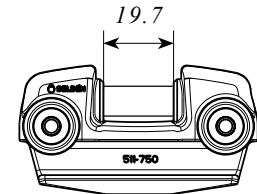

OWS compatible sail feeder gates

The OWS E-section slider (511-740 and 511-750) can be used with, and passes through Seldén sail feeder gate 505-501-01.

The OWS sliders 511-744 and 511-754 for keelboat sections (C106-C139) can be used with and passes through Seldén sail feeder gate 505-533-02.



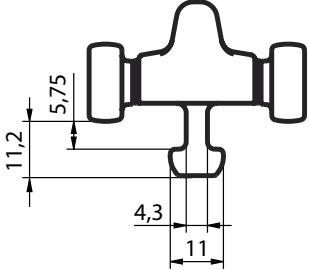
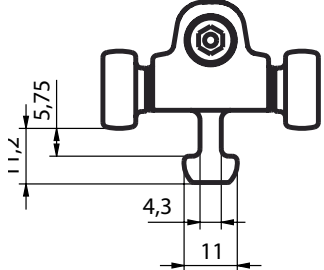
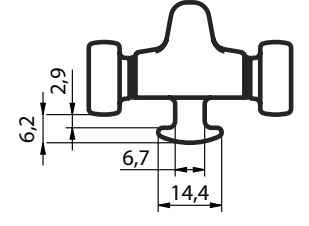
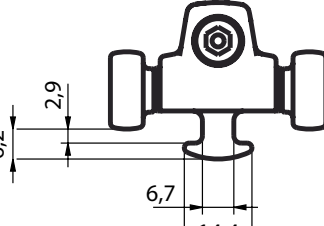
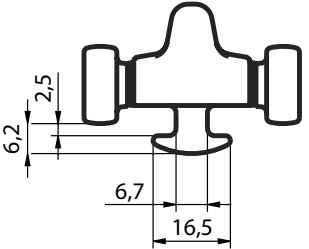
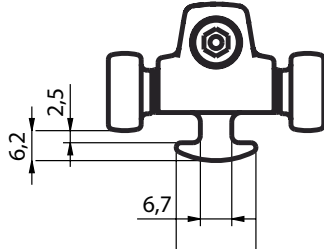
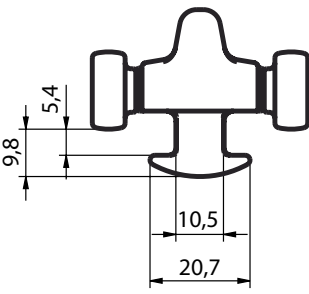
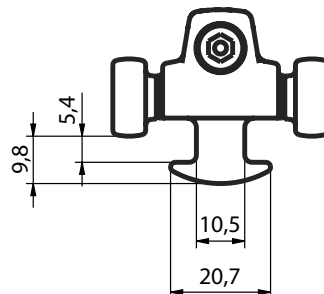
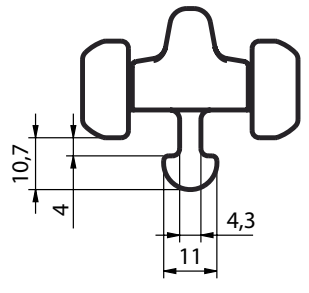
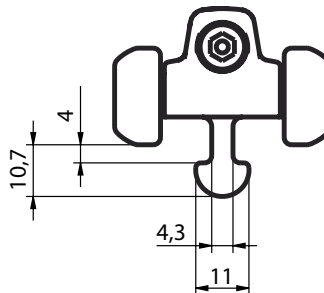























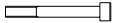























3.5.1 OWS slider - dimensions









Type	Measurements (mm)	Type	Measurements (mm)
OWS slider webbing 511-740		OWS slider batten 511-750	
OWS slider webbing 511-741		OWS slider batten 511-751	
OWS slider webbing 511-742		OWS slider batten 511-752	
OWS slider webbing 511-743 1)		OWS slider batten 511-753 1)	
OWS slider webbing 511-744		OWS slider batten 511-754	

All sliders for webbing can be used for headboard attachments and as intermediate sliders.

1) OWS sliders do not fit Seldén C-section for which MDS-cars, C (2003) or Inner Wheel Sliders, C (2017) should be used.

3.5.2 OWS slider - range

Type	Art. No.	Fits luff groove (mm)	Breaking load (N)	Assembly Art. No.	Parts Art. No.		
OWS slider webbing	 511-740	5.5	5000	 511-740-01			
OWS slider batten	 511-750	5.5	7000	 511-750-03	 511-750-01	 511-739-01 M10 screw	 153-117
				 511-750-02	 511-750-01		 153-117
OWS slider webbing	 511-741	10	5000	 511-741-01			
OWS slider batten	 511-751	10	7000	 511-751-03	 511-751-01	 511-739-01 M10 screw	 153-117
				 511-751-02	 511-751-01		 153-117
OWS slider webbing	 511-742	10	5000	 511-742-01			
OWS slider batten	 511-752	10	7000	 511-752-03	 511-752-01	 511-739-01 M10 screw	 153-117
				 511-752-02	 511-752-01		 153-117
OWS slider webbing	 511-743	12	5000	 511-743-01			
OWS slider batten	 511-753	12	7000	 511-753-03	 511-753-01	 511-739-01 M10 screw	 153-117
				 511-753-02	 511-753-01		 153-117
OWS slider webbing Big wheel	 511-744	5.5	5000	 511-744-01			
OWS slider batten Big wheel	 511-754	5.5	7000	 511-754-03	 511-754-01	 511-739-01 M10 screw	 153-117
				 511-754-02	 511-754-01		 153-117

Type	Fits mast section (only geometric fit)						
OWS slider webbing 511-740 	Seldén			John Mast	Soromap	Sparcraft	Z-spars
	E-section (10° aft face)	E-section (round aft face)	D-section	135D 148D 150D 165D 167D 185D 186D 208D 222D 245D 280D 305D 335D	NF200 NF270 NF350 NF430 NF540 NF710 NF1410	F135 F195 F305 F385 F460 I620 S622 I830 S830	Z301 Z351 Z380 Z401 Z501 Z531 Z601 Z602 Z701 Z702
OWS slider webbing 511-741  OWS slider batten 511-751 							
OWS slider webbing 511-742  OWS slider batten 511-752 							
OWS slider webbing 511-743  OWS slider batten 511-753 				220E 262E 290E		NG60 NG70 NG80 NG86 F580 F740 F1060 F1395 S1630 S2100 F2390 F3360 F4600	Z902 Z1001 Z1250 Z1400
OWS slider webbing Big wheel 511-744  OWS slider batten Big wheel 511-754 	C-section			150E 116E 125E		F35 F50 F67 F78 F101 S137 S180 S260 S330 IMS80 IMS256	Z170 Z190 Z230 Z265

C

3.6 MDS Full batten system for C-masts (2003)

3.6.1 MDS 45 and 68 Full batten system

Part no.	A
511-701-04 ¹⁾	140
511-701-06 ¹⁾	225
511-702-04 ¹⁾	118

1) See 3.6.2

Halyard to be attached in most forward hole of headboard

MDS cars should be used as intermediate connection, fastened via a webbing loop.

Important!
Batten fittings must be allowed to swivel freely or the batten car may not roll properly.
The use of water resistant grease on the M10 thread is recommended.

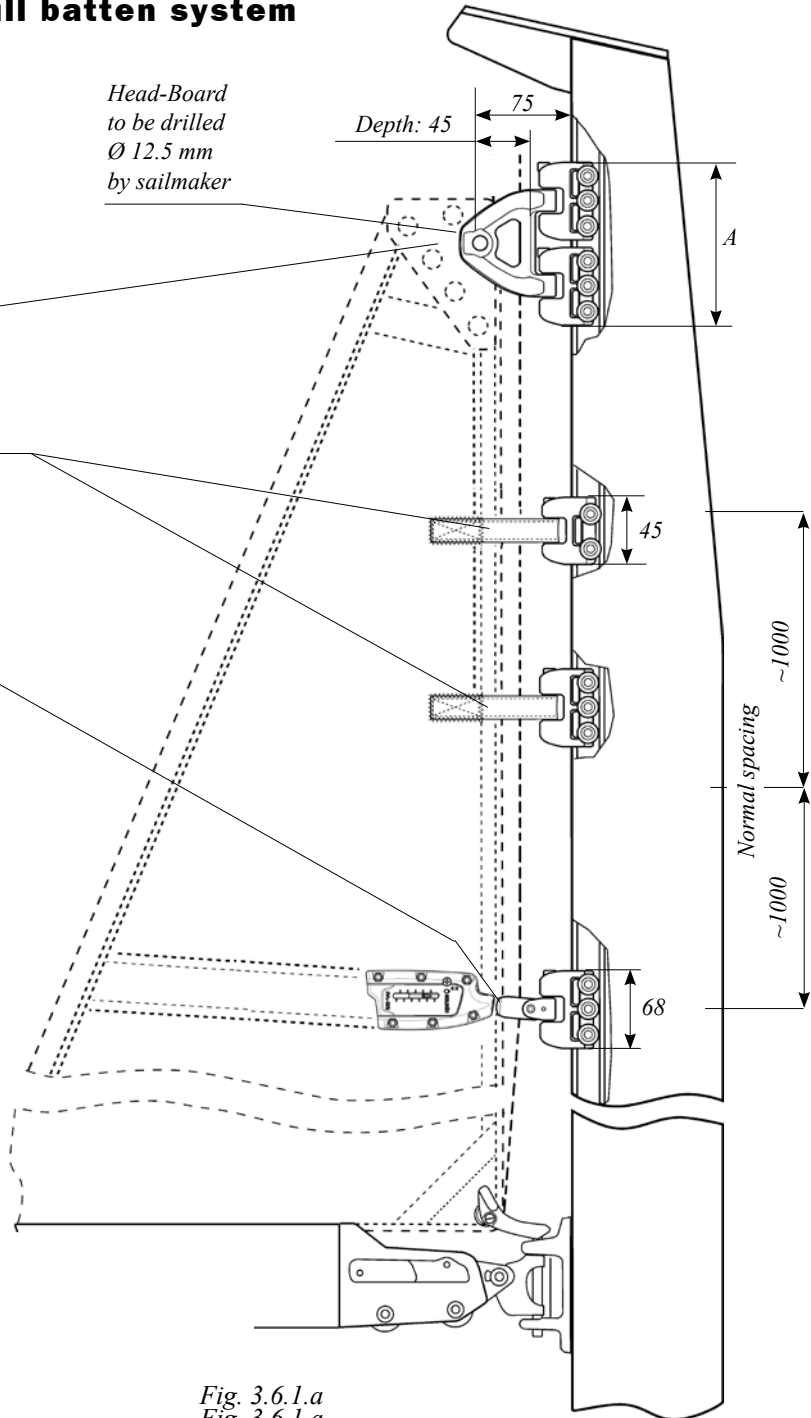
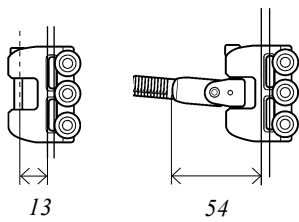
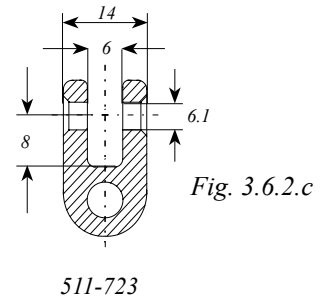
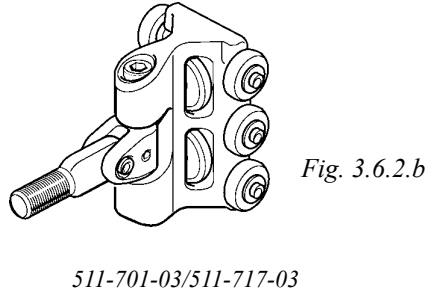
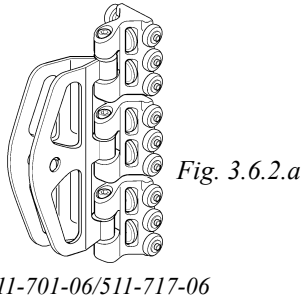

Fig. 3.6.1.a
Fig. 3.6.1.a

	Important! Only MDS car 511-702 MUST be used in the masts sections below. 511-701 is possible to fit but will NOT function properly.		
Mast section	C156	C175	C193
MDS car			
	511-702	511-701	

C

3.6.2 Parts and RM-limits, MDS 45, MDS 68 and MDS 68 ALU



	Assembly	Max RM kNm		Parts	Parts		Section
		Assembly Mh	Frac				
Head board	 511-707-01	90	70	 511-707	 166-234-01		C156 C211 C175 C227 C193 C245
	 511-708-01	160	120	 511-708	 166-234-01		C264 C285 C304
Head board car	 511-702-04	55	40	 511-707-01	 MDS 45 511-702-01	 153-118	C156 C175 C193
	 511-701-04	90	70	 511-707-01	 MDS 68 511-701-01	 153-117	C211 C264 C227 C285 C245 C304
	 511-701-06 MDS 68 ALU 511-717-06	160 330	120 250	 511-708-01	 MDS 68 511-701-01 MDS 68 ALU 511-717-01	 153-117	C211 C264 C227 C285 C245 C304
Batten Car	 511-702-03	90	70	 MDS 45 511-702-01	 511-712-01 M10 screw	 153-118	C156 C175 C193
	 511-702-08			 MDS 45 511-702-01	 511-723 ¹⁾	 153-118	
	 511-701-03 MDS 68 ALU 511-717-03	160 330	120 250	 MDS 68 511-701-01 MDS 68 ALU 511-717-01	 511-712-01 M10 screw	 153-117	C211 C227 C245 C264
	 MDS 68 511-701-08 MDS 68 ALU 511-717-08	160 330	120 250	 MDS 68 511-701-01 MDS 68 ALU 511-717-01	 511-723 ¹⁾	 153-117	C285 C304
Sail Car	 MDS 45 511-702-02	90	70	 MDS 45 511-702-01	 511-719	 153-118	C156 C245 C175 C264 C193 C285 C211 C304 C227
	 MDS 68 511-701-02 MDS 68 ALU 511-717-02	160 330	120 250	 MDS 68 511-701-01 MDS 68 ALU 511-717-01	 511-719	 153-117	C211 C264 C227 C285 C245 C304

1) Measurement see fig. 3.6.2.c.



3.6.3 IWS Full batten system for C-masts, C137, C153, C180 (2017-)

Part no.	A
511-729-04	118

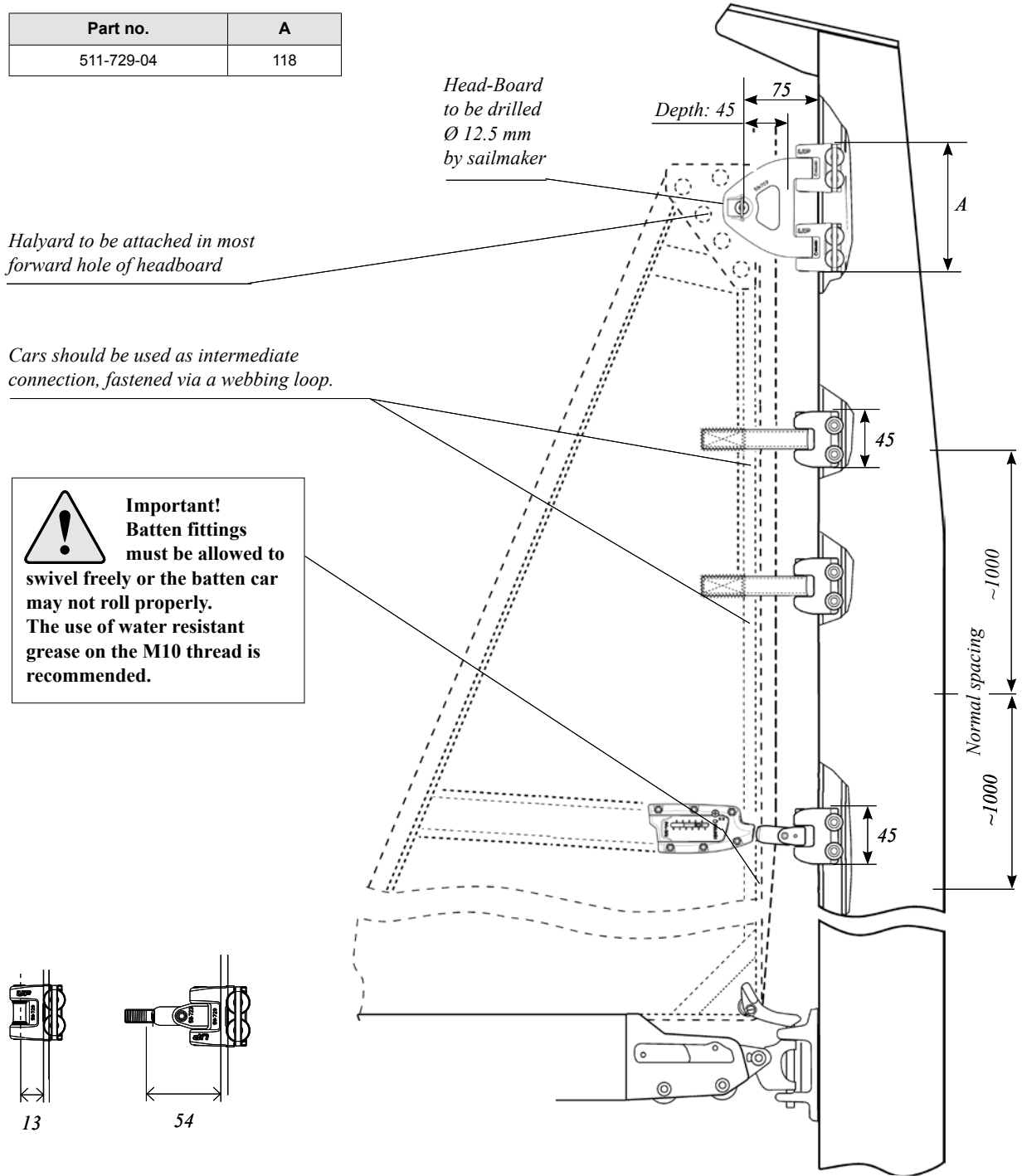
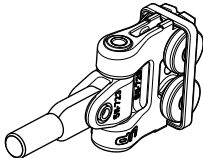

Fig. 3.6.1.a

Inner Wheel Slider	 511-729
--------------------	--

C

3.6.4 Parts and RM-limits, IWS 45, C137, C153, C180

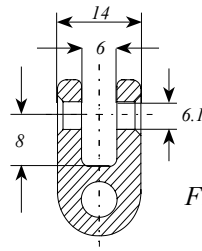

Fig. 3.6.2.c

511-723

	Assembly	Max RM kNm		Parts	Parts	
		Mh	Frac			
Head board	 511-707-01	90	70	 511-707	 166-234-01	
Head board car	 511-729-04	90	70	 511-707-01	 IWS 45 511-729-01	 153-118
Batten Car	 511-729-03	160	120	 IWS 45 511-729-01	 511-712-01 M10 screw	 153-118
	 511-729-08			 IWS 45 511-729-01	 511-723 ¹⁾	 153-118
Sail Car	 IWS 45 511-729-02	90	70	 IWS 45 511-729-01	 511-719	 153-118

1) Measurement see fig. 3.6.2.c.



3.6.5 IWS Full batten system for C-masts, C192, C208, C225, C242, C261, C280 (2017-)

Part no.	A
511-760-04	140
511-760-06	225
511-773-04	118

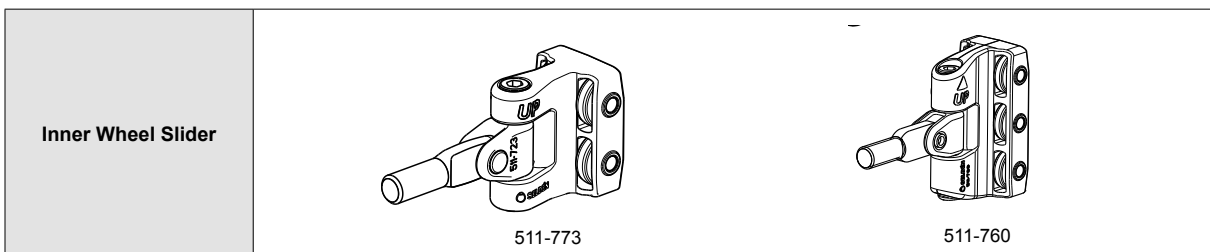
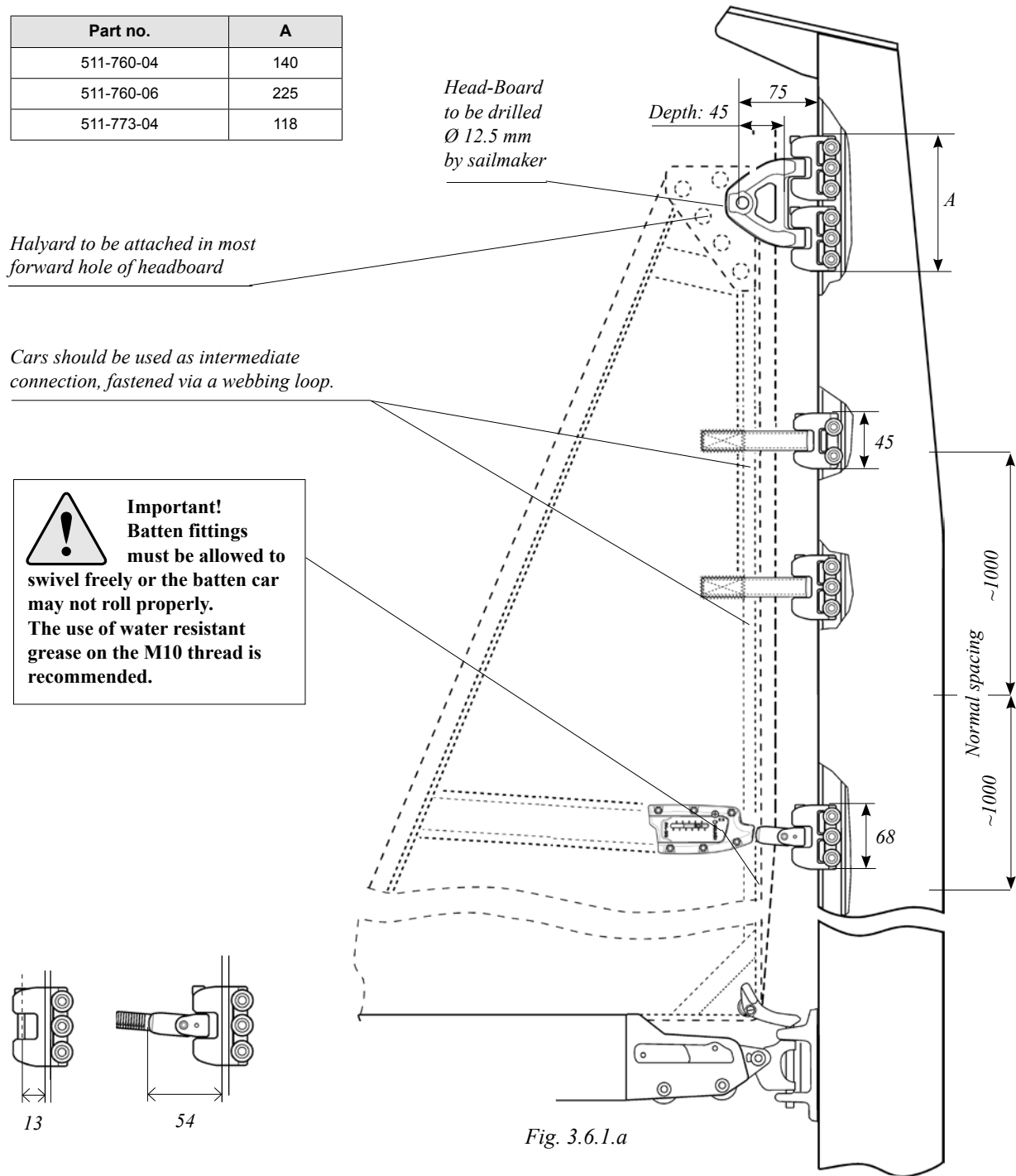

C

**3.6.6 Parts and RM-limits, IWS 45 HD, IWS 68
Masts C192,C208,C225,C242,C261,C280**

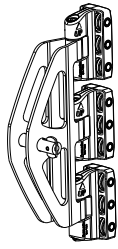

Fig. 3.6.2.a

511-760-06

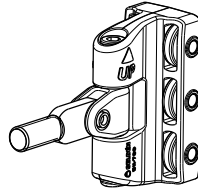

Fig. 3.6.2.b

511-760-03

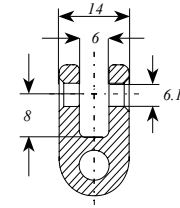

Fig. 3.6.2.c

511-723

	Assembly	Max RM kNm		Parts	Parts	
		Assembly	Mh		Frac	
Head board	 511-707-01	90	70	 511-707	 166-234-01	
	 511-708-01	160	120	 511-708	 166-234-01	
Head board car	 511-773-04	90	70	 511-707-01	 IWS 45 HD 511-773-01	 153-118
	 511-760-04	90	70	 511-707-01	 IWS 68 511-760-01	 153-117
	 511-760-06	330	250	 511-708-01	 IWS 68 511-760-01	 153-117
Batten Car	 511-773-03	160	120	 IWS 45 511-773-01	 511-712-01 M10 screw	 153-118
	 511-773-08			 IWS 45 HD 511-773-01	 511-723 ¹⁾	 153-118
	 511-760-03	160	120	 IWS 68 511-760-01	 511-712-01 M10 screw	 153-117
	 IWS 68 511-760-08	160	120	 IWS 68 511-760-01	 511-723 ¹⁾	 153-117
Sail Car	 IWS 45 HD 511-773-02	90	70	 IWS 45 HD 511-773-01	 511-719	 153-118
	 IWS 68 511-760-02	160	120	 IWS 68 511-760-01	 511-719	 153-117

1) Measurement see fig. 3.6.2.c.

C

3.6.7 MDS 80 Full batten system

Part no.	A
511-730-06	280

Halyard to be attached in most forward hole of headboard to avoid halyard chafe

Headboard to be drilled Ø 15 mm by sailmaker

MDS cars should be used as intermediate connection, fastened via a webbing loop.

Important!
Batten fittings must be allowed to swivel freely or the batten car may not roll properly.
 The use of water resistant grease on the M10 thread is recommended.

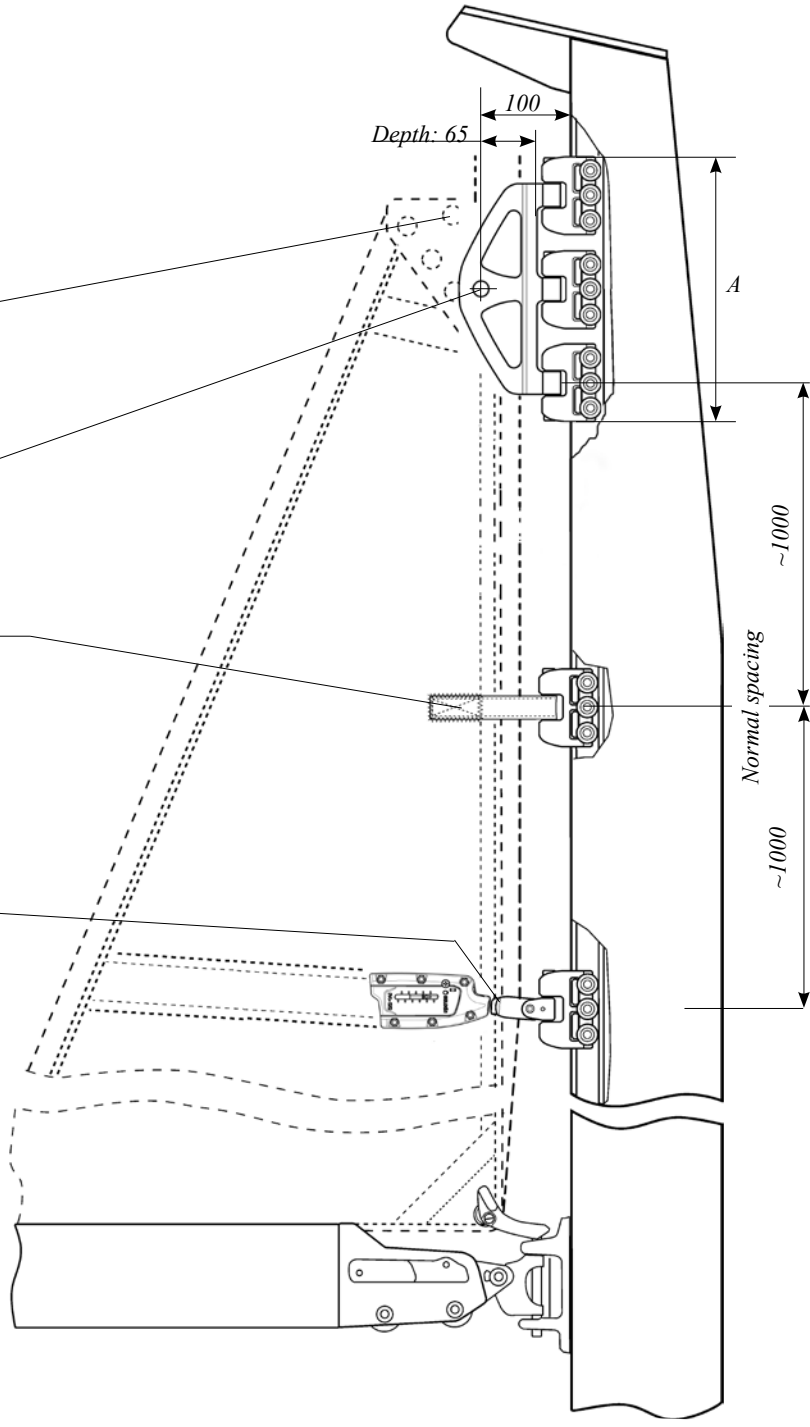
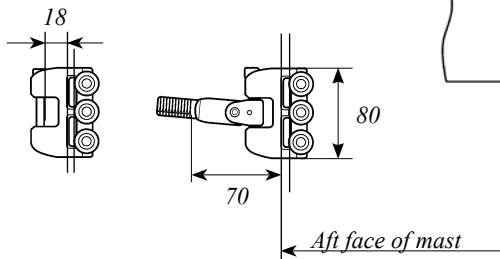

Fig. 3.6.3.a

Fig. 3.6.3.a

C

3.6.8 Parts and RM-limits, MDS 80 and MDS 80 HD*

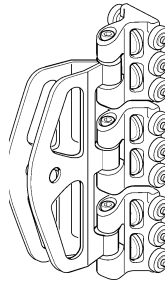

Fig. 3.6.4.a
Fig. 3.6.4.a

511-730-06/511-731-06

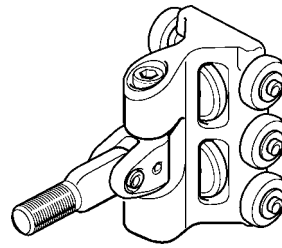
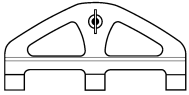

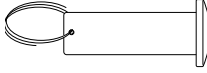
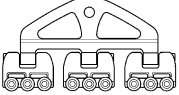
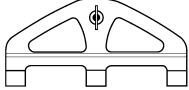

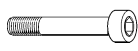



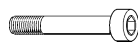

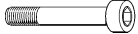

Fig. 3.6.4.b
Fig. 3.6.4.b

511-730-03/511-731-06

	Assembly	Max RM kNm		Parts	Parts	Section
		Mh	Frac			
Head board	 511-728-01	550	450	 511-728	 165-504-01	C321 C365
Head board car	 MDS 80 511-730-06 MDS 80 HD 511-731-06	250 550	200 450	 511-728-01	 511-730-01  153-139	C321 C365
Batten car	 MDS 80 511-730-03 M10 screw MDS 80 511-730-09 M12 screw MDS 80 HD 511-731-03 M10 screw MDS 80 HD 511-731-09 M12 screw	250 550	200 450	 MDS 80 511-730-09 MDS 80 HD 511-731-09	 511-727-01 M12 511-727-02 M10  153-139	C321 C365
Sail car	 MDS 80 511-730-02 MDS 80 HD 511-731-02	250 550	200 450	 MDS 80 511-730-01 MDS 80 HD 511-731-01	 153-139	C321 C365

* MDS 80 HD has machined aluminium body



3.7 Seldén – RCB full batten System 22 and System 30

3.7.1 Dimensions

	RCB 22	RCB 30
A	Min 59	Min 68
C	96	108
D	40	60
E	180	250
F	77	80
G	77	104
K	42	54
L	76	86

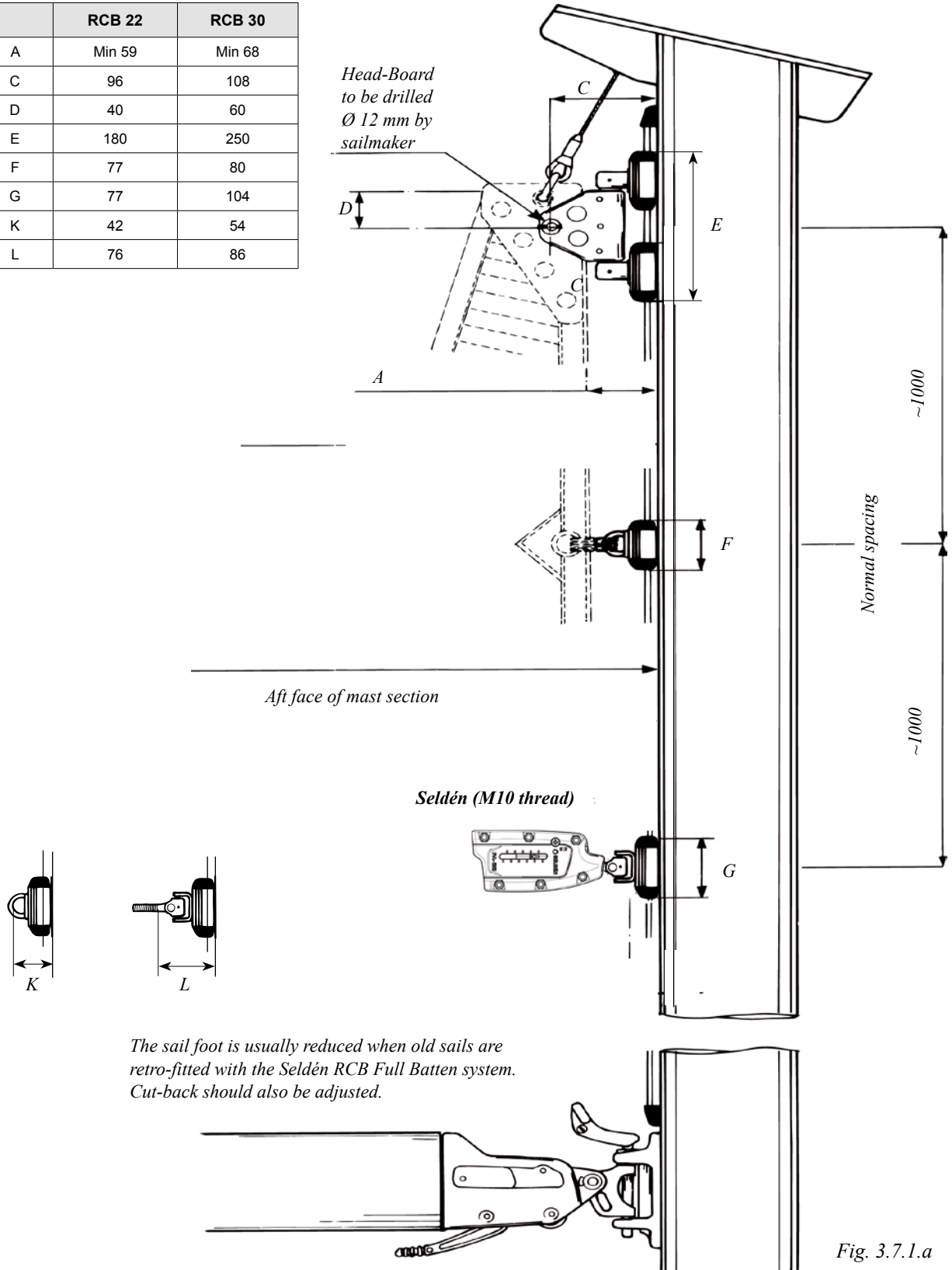

Fig. 3.7.1.a

Fig. 3.7.1.a

D&E

3.7.2 Parts

C

The slide attachment eye is easily detached from the slide and can be sent to the sailmaker separately. It also facilitates fitting the mainsail.

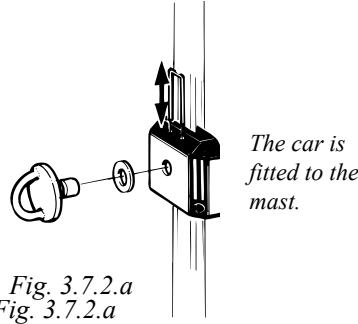

Fig. 3.7.2.a
Fig. 3.7.2.a

		Connectors	Car	Total assembly	
Head-board car					
	RCB 22	511-595-11	511-581-11	511-595-01	
	RCB 22 Light	511-703-11	511-703-11	511-703-11	
	RCB 30	511-695-11	511-681-11	511-695-01	
Batten car All-Round: Fits Rutgerson batten fitting and others					
	RCB 22	511-590-01		511-581-04	
	RCB 22 Light	511-703-11		511-703-11	
	RCB 30	511-690-01		511-681-04	
Batten car With M-10 screw: Fits Bainbridge batten fitting and others					
	RCB 22	511-598-01		511-581-03	
	RCB 22 Light	511-703-11		511-703-11	
	RCB 30	511-692-01		511-681-03	
Sail car					
	RCB 22	511-590-01		511-581-11	511-581-04
	RCB 22 Light	511-703-11		511-703-11	511-703-11
	RCB 30	511-690-01		511-682-11	511-681-04

3.7.3 Try Sail slider
(Part. no.: 511-713)

- Three sliders at the head and tack of the sail c/c 50 mm (2"). Remaining cars to be fitted with c/c ~400 mm (16").
- For sufficient articulation always connect cars to sail via shackles.
- For less friction use Seldén Silicone lubricant (Part No. 312-506) or similar products on the track.
- Breaking load 2.6 kN.

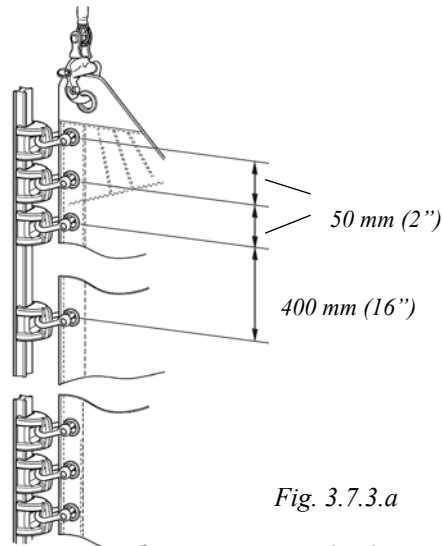

Fig. 3.7.3.a

Fig. 3.7.3.a

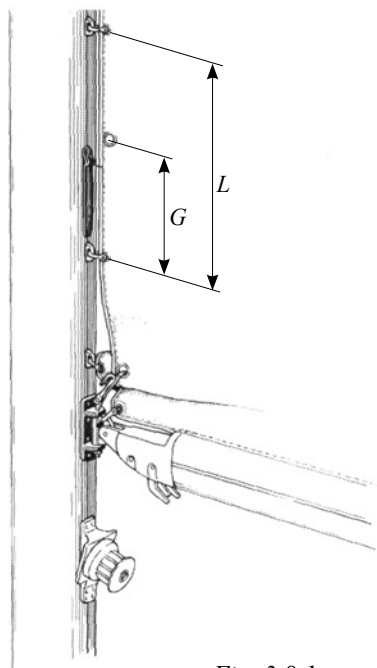

Fig. 3.8.1.a
Fig. 3.8.1.a

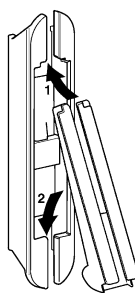

Fig. 3.8.1.b

Sail feeder gate
Art. no. 505-501-01 or
505-503-01 Discontinued

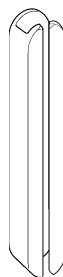

Fig. 3.8.1.c

Sail feeder insert
Art. no. 505-516-01 or
505-524-01 Discontinued

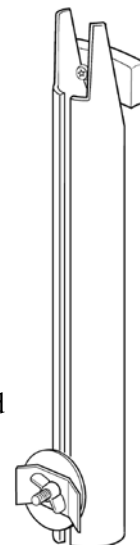

Fig. 3.8.1.d

Sail slide
cassette kit
Art. no.
505-514-01

3.8 Sail Feeder Gates

3.8.1 Seldén E-section Sail Feeder Gate

The Seldén E-section sail feeder gate allows reefing without needing to remove the slides from the luff groove. Ensure that the measurement "G" is sufficient to allow the reef cringle to be hooked on with the slides in place in the luff groove.

"L" = the largest possible slide spacing as recommended by the sailmaker.

Note. Remember that the reef cringles also have "cut-back" to reduce horizontal loading on the nearest slide.

See Reef-hook cut-back "F" or Single Line Reef cut-back "S" at chapter 5, Slab reefing booms.

Section Series E122/85–274/185 & D109/88–160/132

The sail feeder is fitted with a removable gate to permit the mainsail to be fitted with either a luff rope or with slides. See fig. 3.8.1.b. Length of outer oval casing of 505-501-01 is 160 mm, 505-503-01 is 130 mm.

Section Series E126/85–239/162 & P73/53–188/137

From 1977 to 1979 inclusive, these sections were fitted with the sail feeder gate mentioned above. Earlier sections have a dilated luff groove just above the gooseneck fitting to allow either luff rope or slides to be fed in. An extension tube, see fig. 3.8.1.d (part number 505-514-01) is obtainable as extra equipment for these masts. This allows slides to move down the luff groove to the upper edge of the gooseneck fitting, and permits reefing in the same way as in fig. 3.8.1.a.

Sail feeder Gate Insert for Full length Batten Cars

For sails with full batten sliders, a sail groove insert is available (see fig. 3.8.1.c).

This insert was developed for full batten sliders from other brands than Seldén. Seldén's own full batten slider (OWS slider) **does not need this extra insert as the OWS slider can pass through the original Seldén sail feeder gate 505-501-01/505-503-01.**

For other brands of full batten sliders:

Insert 505-516-01 can be fitted instead of the original sail feeder gate 505-501-01. (Sections E138/95-E274/185 & D129/100-D160/132).

Insert 505-524-01 can be fitted instead of the original sail feeder gate 505-503-01. (Sections E122/85, E130/93, D109/88 & D121/92).

C
C156
-
C365

3.8.2 Seldén MDS Sail Feeder Gate - Yacht mast

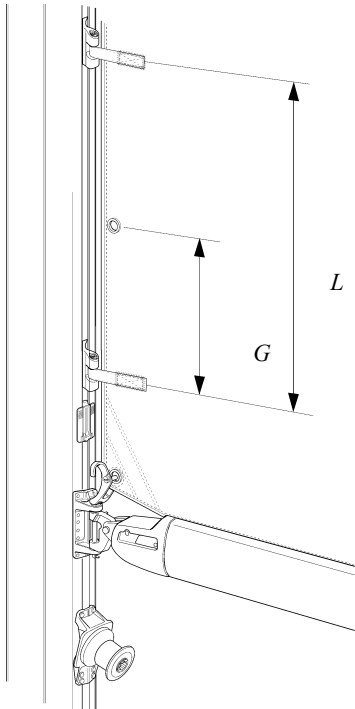

Fig. 3.8.2.a

The Seldén C-section sail feeder gate allows reefing without needing to remove the slides from the luff groove. Ensure that the measurement "G" is sufficient to allow the reef cringle to be hooked on with the slides in place in the luff groove.

"L" = the largest possible slide spacing as recommended by the sailmaker.

Note. Remember that the reef cringles also have "cut-back" to reduce horizontal loading on the nearest slide.

See Reef-hook cut-back "F" or Single Line Reef cut-back "S" at chapter 5, Slab reefing booms.

Fig. 3.8.2.b
MDS Sail feeder gate for C156-C304
Part. no. 505-519-01

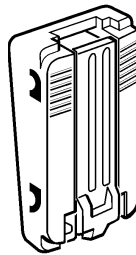
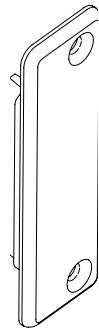

Fig. 3.8.2.c
MDS Sail feeder gate for C321 and C365
Part. no. 507-309-01



Instructions for the MDS sail feeder gate.

The MDS-sail feeder gate is designed for use with MDS cars or conventional sail sliders. When using MDS cars, simply remove the sail feeder gate when installing or removing the cars. When using it with conventional sliders, feed the sliders through the spring-loaded mid section of the sail feeder gate.

Feeding MDS Cars	Feeding Sail sliders
<p style="text-align: center;">Fig. 3.8.2.d</p>	<p style="text-align: center;">Fig. 3.8.2.e</p>
<p>Sail feeder gate is easily removed to fit or remove Seldén MDS cars.</p> <ol style="list-style-type: none"> 1. Press at the bottom of the middle gate. 2. Push the Sail feeder gate body downwards. 	<p>Sail feeder gate is designed for use with Seldén MDS cars or conventional sail sliders.</p>

3.8.3 Seldén IWS Sail Feeder Gate - Yacht mast

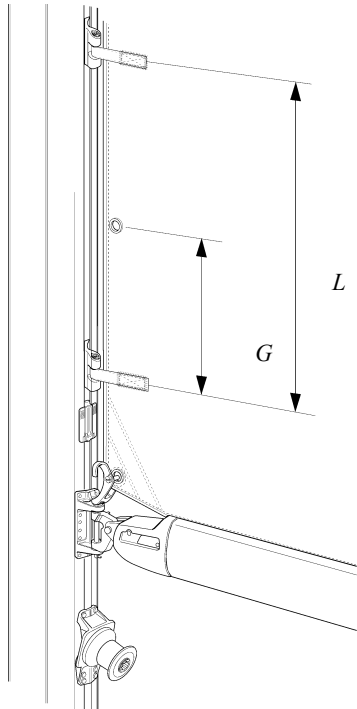

Fig. 3.8.2.a

The Seldén C-section sail feeder gate allows reefing without needing to remove the slides from the luff groove. Ensure that the measurement "G" is sufficient to allow the reef cringle to be hooked on with the slides in place in the luff groove.

"L" = the largest possible slide spacing as recommended by the sailmaker.

Note. Remember that the reef cringles also have "cut-back" to reduce horizontal loading on the nearest slide.

See Reef-hook cut-back "F" or Single Line Reef cut-back "S" at chapter 5, Slab reefing booms.

Fig. 3.8.2.b
IWS Sail feeder gate for C137-C180
Part. no. 505-552-01

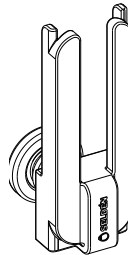
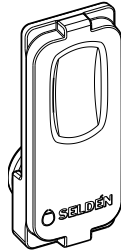
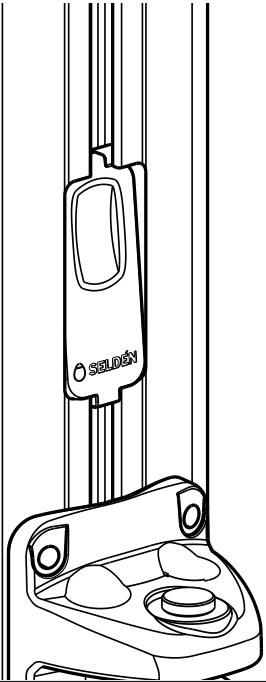
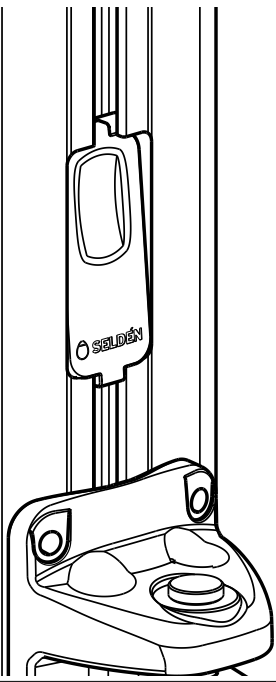

Fig. 3.8.2.c
IWS Sail feeder gate for C192-C280
Part. no. 505-554-01



Instructions for the IWS sail feeder gate.

The IWS-sail feeder gate is designed for use with IWS cars or conventional sail sliders. When using IWS cars, simply remove the sail feeder gate when installing or removing the cars. When using it with conventional sliders, feed the sliders with gate in position.

Feeding IWS Cars	Feeding Sail sliders
 <p style="text-align: right;">Fig. 3.8.2.d</p>	
<p>Sail feeder gate is easily removed to fit or remove Seldén IWS cars.</p> <ol style="list-style-type: none"> 1. Press at the top of the gate. 2. Push the Sail feeder gate body upwards. 	<p>Sail feeder gate is designed for use with Seldén IWS cars or conventional sail sliders.</p>

C
C080
-
C139

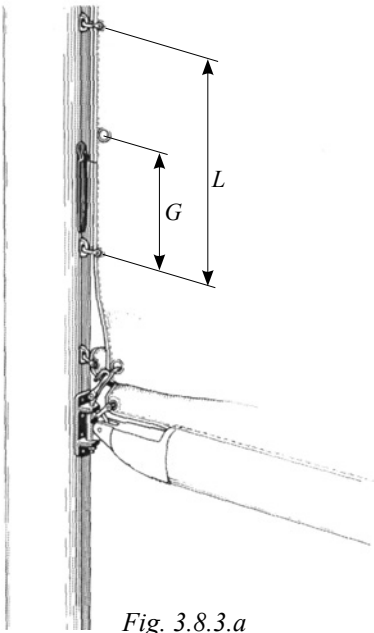

3.8.4 Seldén Sail feeder Gate - Keelboat

The Seldén C-section sail feeder gate allows reefing without needing to remove the slides from the luff groove. Ensure that the measurement "G" is sufficient to allow the reef cringle to be hooked on with the slides in place in the luff groove.

"L" = the largest possible slide spacing as recommended by the sailmaker.

Note. Remember that the reef cringles also have "cut-back" to reduce horizontal loading on the nearest slide.

See Reef-hook cut-back "F" or Single Line Reef cut-back "S" at chapter 5, Slab reefing booms.

Section Series C080 - C139

The sail feeder is fitted with a removable gate to permit the mainsail to be fitted with either a luff rope or with slides. See fig. 3.8.3.b.

How to fit sail feeder

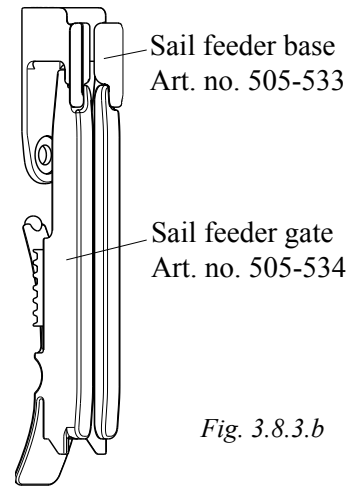
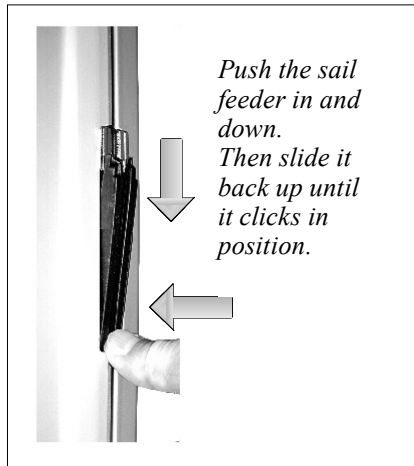
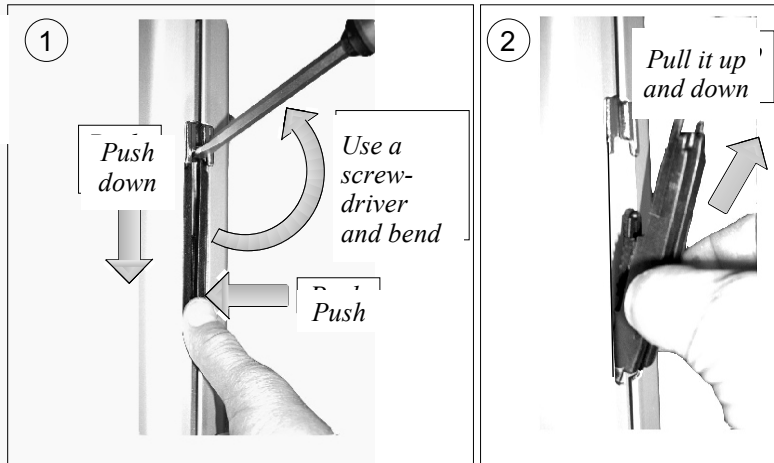

Fig. 3.8.3.b

How to remove sail feeder



4 Batten receptacles

Batten receptacles

Each size of the adjustable batten receptacles is available in two models to ensure correct fit on round, flat and rectangular battens.

Safety cord secures the cover to the body.

The FA-models have access to the adjustment screw both front and rear which enables adjustment of the batten even when the sail is flaked on the boom. The adjustment screw is compatible with multiple screw heads.

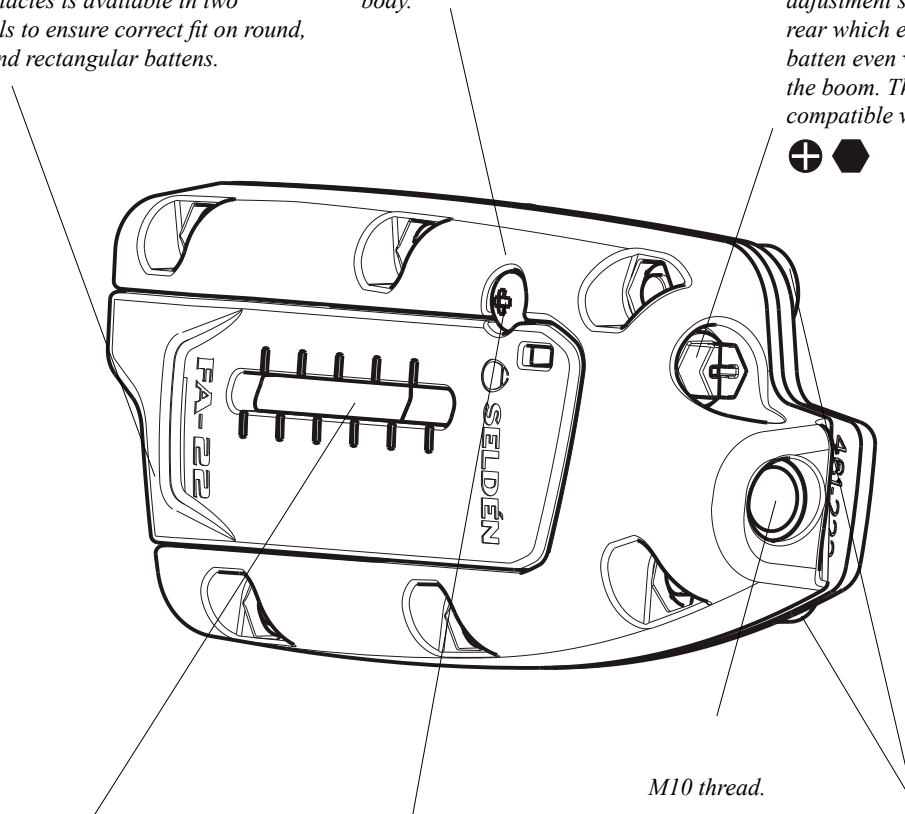

Indicators to record batten tension for the ultimate trim.

Easy set up and removal of batten with sliding cover and a locking screw. No need to fully release the screw to remove the cover.

Protecting collar at the backing plate prevents the forward screw heads to chafe on the mast surface.

4.1 Batten receptacle fittings

The fittings are designed to be used with toggle M10 stud (511-712-01, 511-727-02 or 511-739-01).

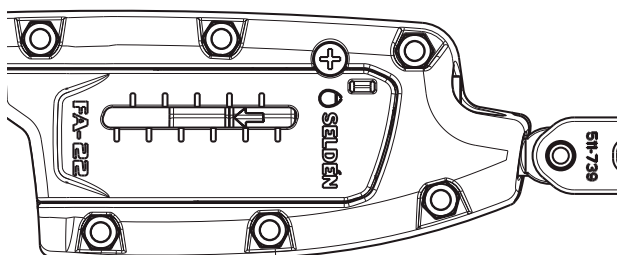

Fig. 4.1.a

The adjustable batten receptacles are available for either round or rectangular battens.

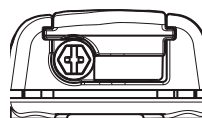

Fig. 4.1.b
(461-210-01)

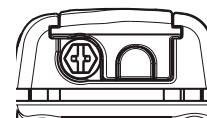

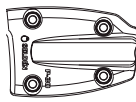

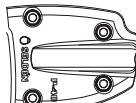

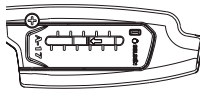

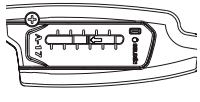

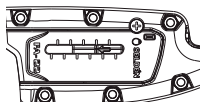

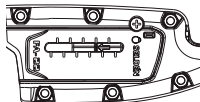

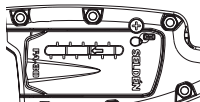

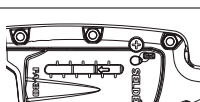

Fig. 4.1.c
(461-210-02)

4.2 Batten receptacle range

Type	Art. No.	Batten sizes (mm)		Batten receptacle	Adj. length (mm)	Stud dim.
		Round	Flat			
P-30	461-237-01	Ø10	5.5x31	 	-	M10
P-40	461-235-01	Ø10	5.5x41	 	-	M10
A-17	461-210-01	-	6.5x18	 	38	M10
	461-210-02	Ø8	-	 		
FA-22	461-220-01	-	9.5x23	 	33	M10
	461-220-02	Ø10	-	 		
FA-30	461-230-01	-	6.5x31	 	36	M10
	460-230-02	Ø12	-	 		

5 Seldén booms

Boom ID engraved on most boom extrusions to simplify identification

Boom	Dim	Section Geometry	Luff foot groove mm	T-track	Comment
85/58	85/58	A	4.0±0.5	16mm	Produced ~1977-1991
86/59	85/59	A	4.5±0.5	16mm	Produced ~1992-2010
B087	86/60	B	5.5±0.6	20mm	In production since 2006
B104	104/60	B	5.5±0.6	20mm	In production since 2006
111/75	111/75	A	5.5±0.75	25mm	Produced ~1977-1991
B120 (120/62)	120/62	B	5.5±0.75	25mm	In production since 1991. Design update & renamed to B120 in 2008.
B128/90	128/90	A	5.5±0.75	25mm	
B134	134/74	B	5.5±0.75	25mm	In production since 2023, Replacing B135
B135	135/71	B	5.5±0.75	25mm	In production since 2006. Replaced by B134
B143 (143/76)	143/76	B	5.5±0.75	25mm	Produced ~1992-2007. Design update & renamed to B143 in 2008.
150/105		A	5.5±0.75	25mm	
B152	152/82	B	5.5±0.75	25mm	Produced 2005-2018. Replaced by B153
B153	153/86	C	10+/-0.75	25mm	In production since 2018.
162/125		A	5.5±0.75	25mm	
B171 (171/94)	171/94	B	5.5±0.75	25mm	Produced 1991-2016. Replaced by B172. Design update & renamed to B171 in 2008.
B172	171/98	C	10+/-0.75	25mm	In production since 2016
B190	190/60	D	5.5±0.75	25mm	In production since 2006
B199	199/122	C	10+/-0.75	32mm	In production since 2018
B200 (200/117)	200/117	B	6.25±0.75	32mm	Produced 1991-2018. Replaced by B199. Design update & renamed to B200 in 2008.
B230	230/70	D	6.25±0.75	32mm	In production since 2006
B232	232/138	C	11±0.75	32mm	New 2019
B250 (250/140)	250/140	B	6.25±0.75	32mm	Produced 1991-2019. Design update & renamed to B250 in 2008
B256	256/156	C	11±0.75	32mm	New 2019
B290	290/155	E	10+/-0.75	32mm	New 2008
B300	300/155	E	6.25±0.75	32mm	New 1993 replaced by B290 2008
B380	380/186	F	No track	No track	New 2010

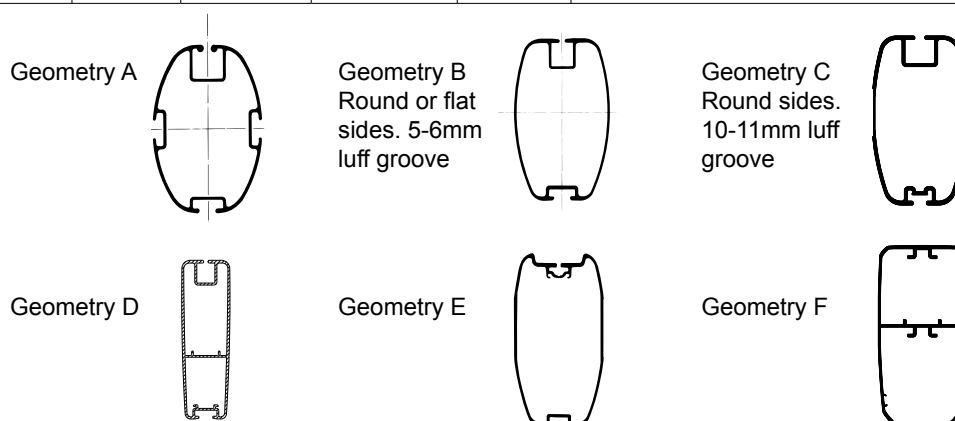



5 Slab reefing booms

5.1 Boom sections on conventional masts (through 1991) (Tacks, reefing hooks etc) Slab reefing and roller reefing on older booms

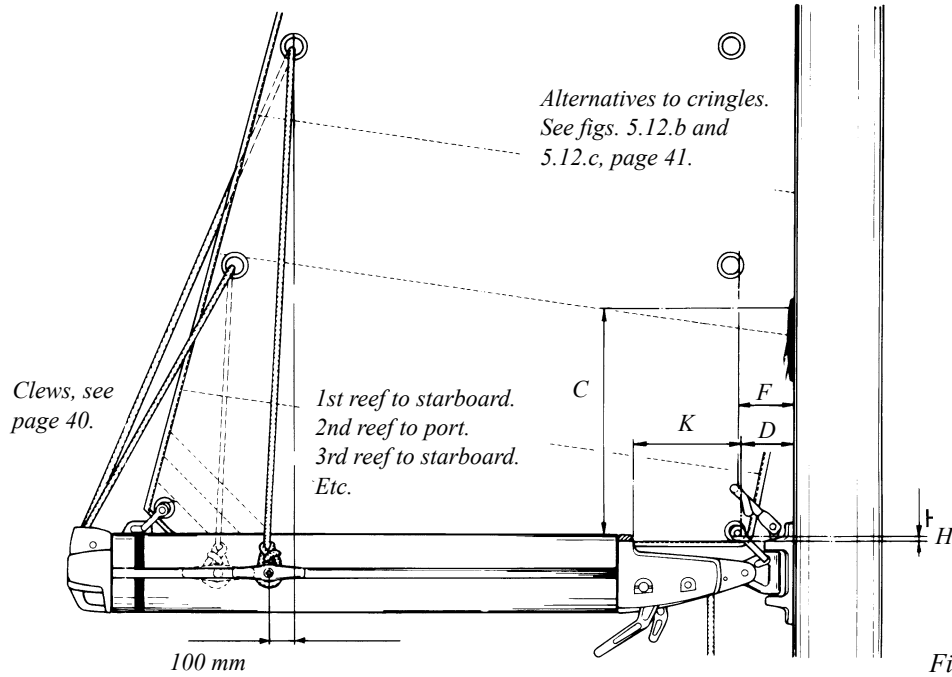

Fig. 5.1.a

	Boom section	Sail feeder gate "cut-back"		Tack		Reef hooks	No. of internal reefing lines	Reef line attachment at aft end of boom
		C mm	K mm	D mm	H mm	F mm		
	Grooved Section 1977-1991							Reefing line tied fast to slide on the boom. Free choice of number of slides.
	85/58	600	190	60	0	50	2	
	86/59	600	190	60	0	50	2	
	111/75	830	205	75	10	65	2	
	128/90	830	225	75	20	65	2	
	150/105	830	265	60	30	105	3	
	162/125	830	330	60	25	105	4	
	E-Section 1982-1991							Reefing line tied around boom; see fig. 5.2.a, page 32.
	189/132	830	330	60	25	105	4	
	206/139	830	330	60	25	105	4	
	P-Section 1969-1980	Several variations exist. Spars must be individually measured.				Usually roller reefing booms, but also slab-reefing booms with external reefing lines occur.		Adjustable slides on tracks occur, but reefing lines can also be tied around boom. See fig. 5.2.a page 32.
	73/53							
	90/65							
	111/81							
	137/100							

5.2 Traditional slab-reefing booms from 1991 inclusive 2003



Important!

1. The reefing line is tied as illustrated, with a bowline and running noose. No. 1 reef is shown. Note that grommets are required along the foot for each reef.
2. For loose-footed sails, the reef line loop must be held in the correct position along the boom, to ensure proper reefing. Seldén's eye slider can be used for this. (See table 5.13).

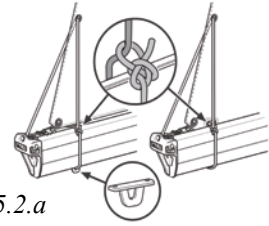

Fig. 5.2.a

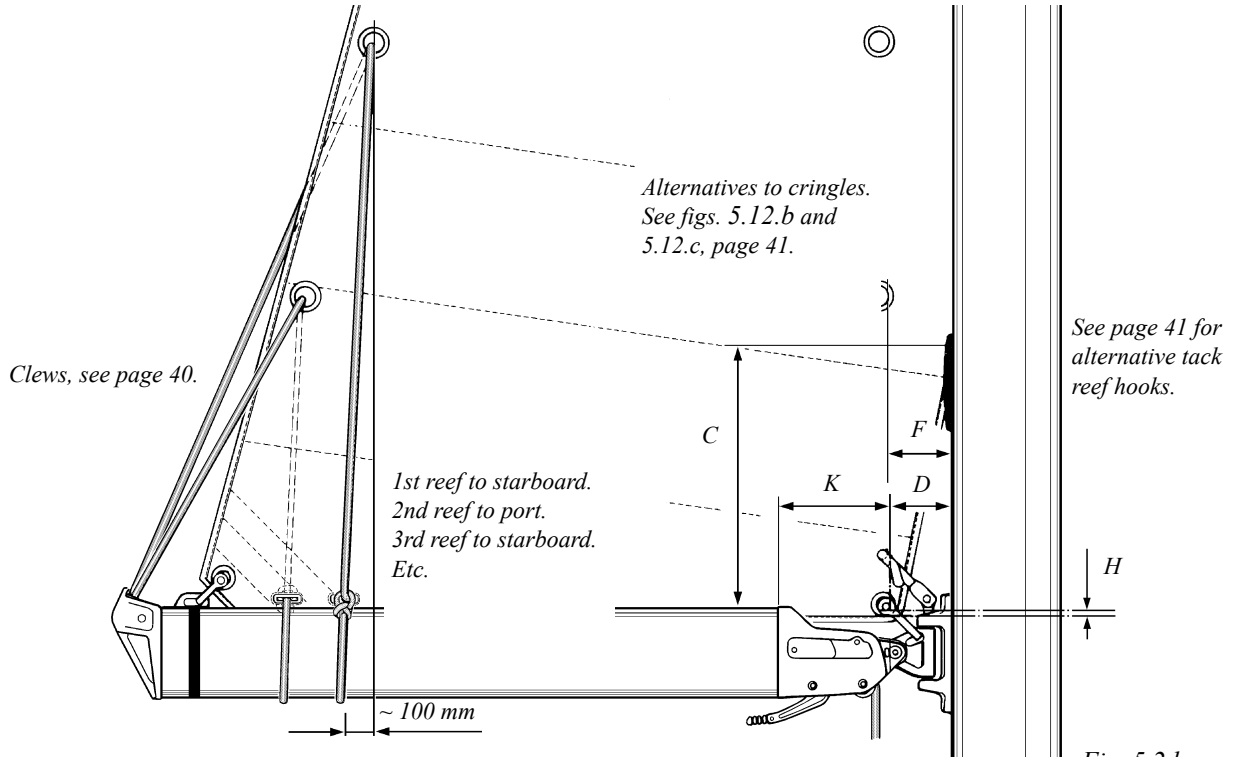

Fig. 5.2.b

	Boom section	Sail feeder gate "cut-back"		Tack		Reef hooks	No. of internal reefing lines	Reef line attachment at aft end of boom
		C mm	K mm	D mm	H mm			
	120/62	830	215	75	10	65	2 slab reefs + 1 flattening reef	Reefing line tied around boom; see fig. 5.2.a.
	143/76	830	160	80	20	80	3 slab reefs	
	171/94	830	190	80	20	80	3 slab reefs	
	200/117	830	250	100	20	110	4 slab reefs	
	250/140	830	275	100	20	110	4 slab reefs	
	300/155	830	100	77	37	Running hook page 41	2-4 slab reefs	

C

5.3 Traditional slab-reefing booms on C-mast from 2003 - 2007



Important!

1. The reefing line is tied as illustrated, with a bowline and running noose. No. 1 reef is shown. Note that grommets are required along the foot for each reef.
2. For loose-footed sails, the reef line loop must be held in the correct position along the boom, to ensure proper reefing. Seldén's eye slider can be used for this. (See table 5.13).

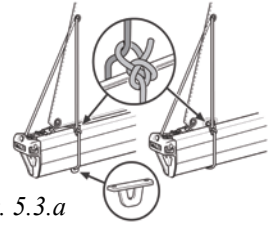

Fig. 5.3.a

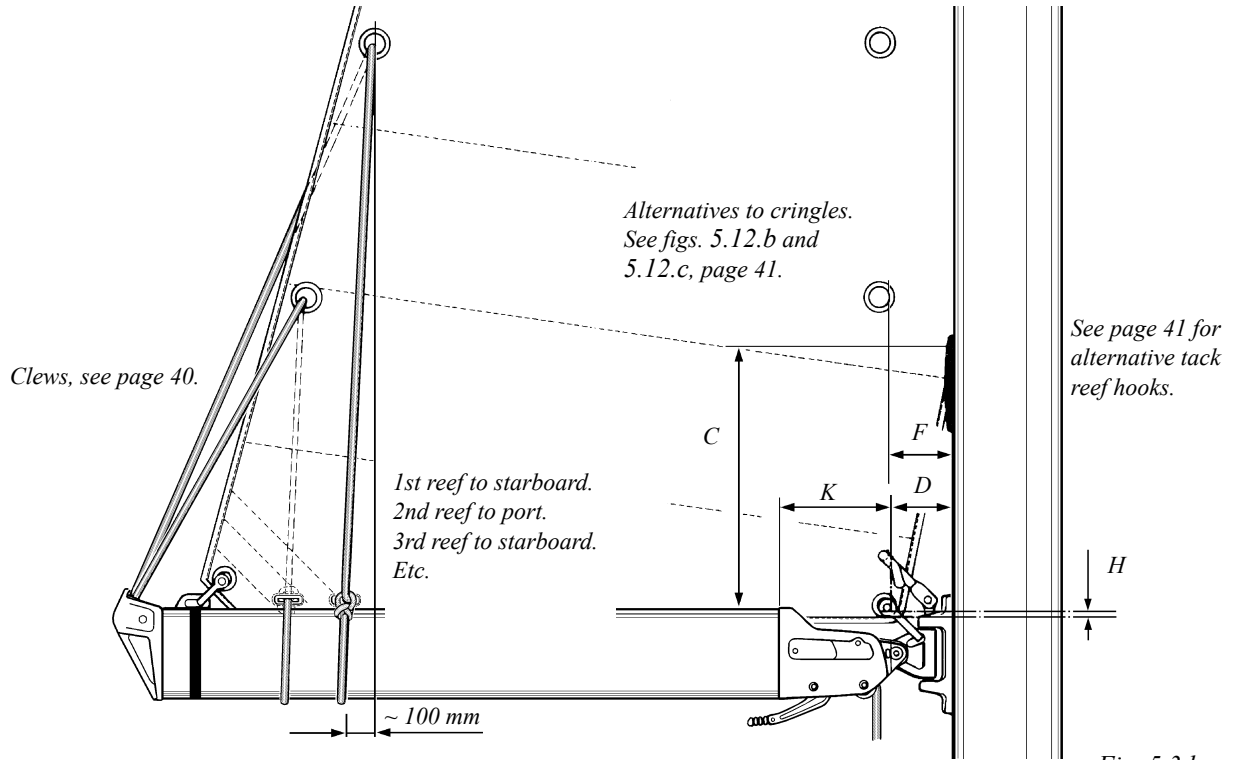

Fig. 5.3.b

Mast section	Boom section	Sail feeder gate "cut-back"			Tack			Reef hooks	No. of internal reefing lines	Reef line attachment at aft end of boom
		C (MDS slides) mm	C (bolt rope) mm	K mm	D mm	H mm	F mm			
C156	120/62	130	850	150	80	35	80	2 slab reefs + 1 flattening reef	Reefing line tied around boom; see fig. 5.3.a.	
C175	143/76	110	830	165	80	20	80	3 slab reefs		
C193								3 slab reefs		
C211	171/94	110	830	195	80	20	80	3 slab reefs		
C227	200/117	110	830	270	80	20	80	4 slab reefs		
C245								4 slab reefs		
C264	171/94	180	830	210	100	45	110	3 slab reefs		
C285	200/117	150	830	250	100	20	110	4 slab reef		
C304	250/140	150	830	275	100	20	110	4 slab reef		
	300/155	170	830	75	100	35	Running hook page 41	2-4 slab reefs		

C

5.4 Traditional slab-reefing booms on C-mast from 2008



Important!

1. The reefing line is tied as illustrated, with a bowline and running noose. No. 1 reef is shown. Note that grommets are required along the foot for each reef.
2. For loose-footed sails, the reef line loop must be held in the correct position along the boom, to ensure proper reefing. Seldén's eye slider can be used for this. (See table 5.13).

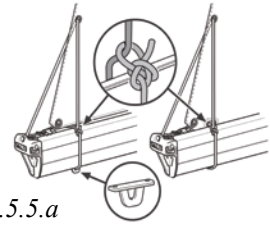
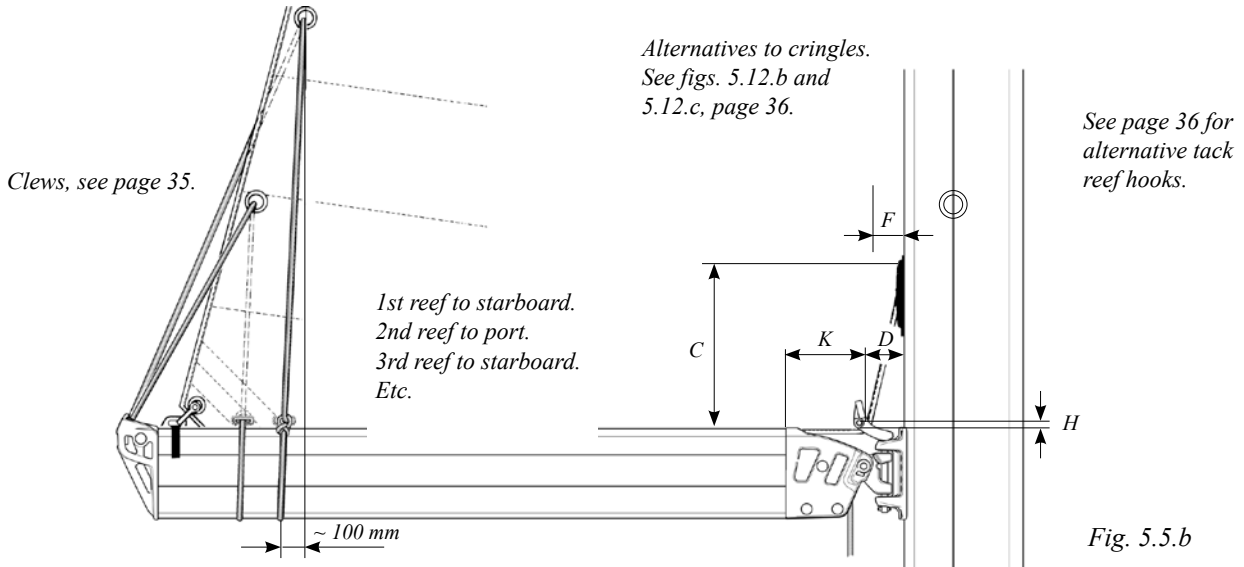

Fig. 5.5.a



See page 36 for alternative tack reef hooks.

Fig. 5.5.b

Mast section	Boom section	Sail feeder gate "cut-back"			Tack			Reef hooks	No. of internal reefing lines	Reef line attachment at aft end of boom
		C (MDS slides) mm	C (bolt rope) mm	K mm	D mm	H mm	F mm			
C080 C087 C096 C106	C116 C126 C139	B087	~	600	55	55	0	70	2 slab reefs	Reefing line tied around boom; see fig. 5.5.a.
		B104	~	600	55	55	0	70	2 slab reefs	
		B120	~	600	165	65	20	70	2 slab reefs	
C126 C139		B120	~	600	165	65	20	70	2 slab reefs	
C156 C175 C193 C211 C227 C245	C137 C153 C180 C192 C208 C225	B087	130	750	55	65	20	70	2 slab reefs	
		B104								
		B120	130	750	150	80	35	80	2 slab reefs + 1 flattening reef	
		B134	130	750	85	80	30	80	3 slab reefs	
		B135	130	750	125	80	30	80	3 slab reefs	
		B152	120	750	105	80	20	80	3 slab reefs	
		B153	120	750	70	80	20	80	3 slab reefs	
		B171	110	750	120	80	20	80	3 slab reefs	
		B172	110	750	100	80	20	65	3 slab reefs	
		B199	170	750	100	100	15	80	3 slab reefs	
		B200	170	750	175	100	15	80	4 slab reefs	
C264 C285 C304	C242 C261 C280	B171	180	750	135	100	45	110	3 slab reefs	
		B172	180	750	110	100	50	95	3 slab reefs	
		B199	150	750	100	100	15	110	4 slab reefs	
		B200	150	750	175	100	15	110	4 slab reefs	
		B232	157	750	65	80	10	90	4 slab reefs	
		B250	157	750	205	100	15	110	4 slab reefs	
		B256	157	750	115	80	10	90	4 slab reefs	
		B290	170	750	75	100	35		Running hook page 41	2-4 slab reefs
		B300								
C365		B380	210	-	150	80	0			
C405			-							

5.5 Single line reef booms from 1991 - 2003



Important!

1. The reefing line is tied as illustrated, with a bowline and running noose. No. 1 reef is shown. Note that grommets are required along the foot for each reef.
2. For loose-footed sails, the reef line loop must be held in the correct position along the boom, to ensure proper reefing. Seldén's eye slider can be used for this. (See table 5.13).

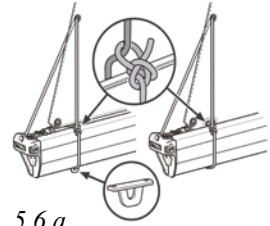

Fig. 5.6.a

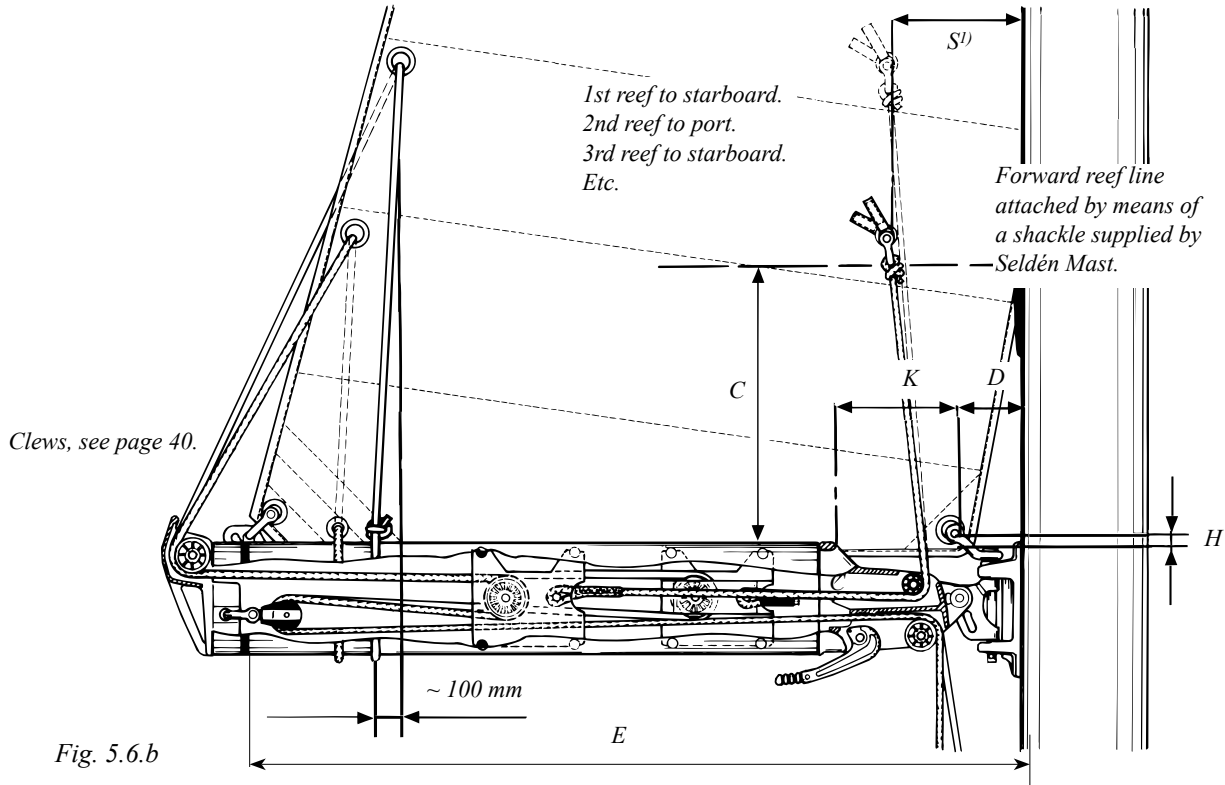

Fig. 5.6.b

	Boom section	Sail feeder gate "cut-back"		Tack		Single line reef	No. of internal reefing lines	Reef line attachment	Max height for reef 1 (Starboard) ³⁾	Max height for reef 2 (Port) ³⁾
		C mm	K mm	D mm	H mm					
	120/62	830	215	75	10	120	2 single line + 1 flattening	Reef line attached as per fig. 5.6.a	E-1800	E-600
	143/76	830	160	80	20	140			E-1800	E-700
	171/94	830	190	80	20	150			E-1900	E-850
	200/117	830	250	100	20	190			E-2000	E-950
	250/140	830	275	100	20	200			E-2500	E-1100

1) The "S" measurement includes the shackle supplied by Seldén Mast.

2) Running Reef Hooks as shown on page 41 should be used for traditional 3rd and 4th slab reefs in conjunction with Single Line Reefs. If permanent reef hooks are used at the tack there is a risk that the sail can snag when a Single Line Reef is shaken out.

3) "Max height" information refer to forward reef cringle only.

Comprehensive instructions on Single Line reefs can be obtained from Seldén Mast; reference No 595-664-SET, (in Swedish, English and German).

5.6 Single line reef booms on C-mast from 2003 - 2007



Important!

1. The reefing line is tied as illustrated, with a bowline and running noose. No. 1 reef is shown. Note that grommets are required along the foot for each reef.
2. For loose-footed sails, the reef line loop must be held in the correct position along the boom, to ensure proper reefing. Seldén's eye slider can be used for this. (See table 5.13).

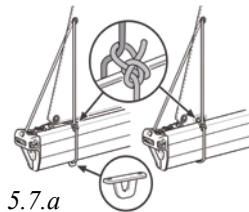

Fig. 5.7.a

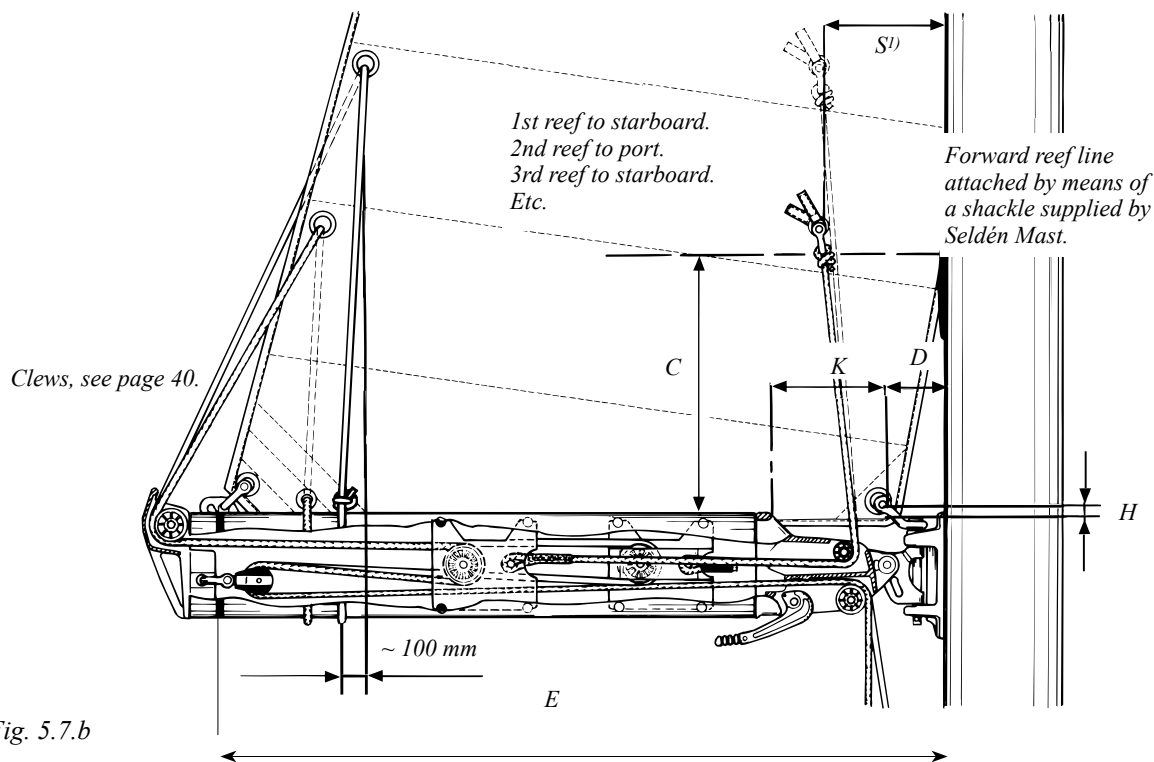

Fig. 5.7.b

Mast section	Boom section	Sail feeder gate "cut-back"		Tack			Single line reef S ¹⁾	No. of internal reefing lines	Reef line attachment	Max height for reef 1 (Starboard) 3) mm	Max height for reef 2 (Port) 3) mm	
		C (MDS slides) mm	C (bolt rope) mm	K mm	D mm	H mm						
C156 C175 C193 C211 C227 C245	120/62	130	850	150	80	35	120	2 single line + 1 flattening	Reefing line tied around boom; see fig. 5.7.a.	E-1800	E-600	
	143/76	110	830	165	80	20	140			2 single line + 1 traditional slab reef ²⁾	E-1800	E-700
	171/94	110	830	195	80	20	150			2 single line + 2 traditional slab reefs ²⁾	E-1900	E-850
	200/117	110	830	270	80	20	190				E-2000	E-950
C264 C285 C304	171/94	180	830	210	100	45	180	2 single line + 1 traditional slab reefs ²⁾	Reefing line tied around boom; see fig. 5.7.a.	E-1900	E-850	
	200/117	150	830	250	100	20	190	2 single line + 1 traditional slab reefs ²⁾		E-2000	E-950	
	250/140	150	830	275	100	20	200	2 single line + 1 traditional slab reefs ²⁾		E-2500	E-1100	

1) The "S" measurement includes the shackle supplied by Seldén Mast.

2) Running Reef Hooks as shown on page 41 should be used for traditional 3rd and 4th slab reefs in conjunction with Single Line Reefs. If permanent reef hooks are used at the tack there is a risk that the sail can snag when a Single Line Reef is shaken out.

3) "Max height" information refer to forward reef cringle only.

Comprehensive instructions on Single Line reefs can be obtained from Seldén Mast; reference No 595-664-SET, (in Swedish, English and German).

C

5.7 Single line reef booms on C-mast from 2008



Important!

1. The reefing line is tied as illustrated, with a bowline and running noose. No. 1 reef is shown. Note that grommets are required along the foot for each reef.
2. For loose-footed sails, the reef line loop must be held in the correct position along the boom, to ensure proper reefing. Seldén's eye slider can be used for this. (See table 5.13).

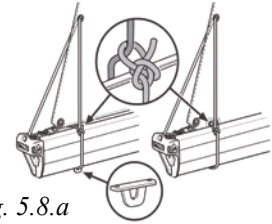

Fig. 5.8.a

Clews, see page 40.

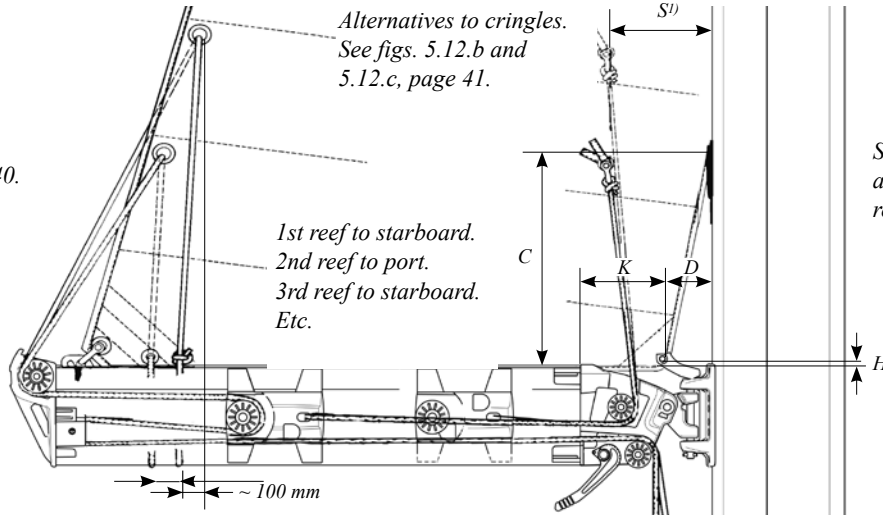

Fig. 5.8.b

Mast section	Boom section	Sail feeder gate "cut-back"			Tack			Single line reef S ¹⁾	No. of internal reefing lines	Reef line attachment	Max height for reef 1 (Starboard) ³⁾ mm	Max height for reef 2 (Port) ³⁾ mm
		C (MDS slides) mm	C (bolt rope) mm	K mm	D mm	H mm						
C080 C087 C096 C106 C116 C126 C139	B087	~	600	55	55	0	95	2 single line	Reefing line tied around boom; see fig. 5.8.a.	E-1650	E-450	
	B104	~	600	55	55	0	95	2 single line		E-1650	E-450	
C126 C139	B120	~	600	165	65	20	70	2 single line		E-1650	E-450	
C156 C137	B087 B104	130	750	165	65	20	105	-		-	-	
C156 C137 C175 C153 C193 C180 C211 C192 C227 C208 C245 C225	B120 B134 B135 B152 B153 B171 B172 B199 B200	130 130 130 120 120 110 110 170 170	750 750 750 750 750 750 750 750 750	150 85 125 105 70 120 100 100 175	80 80 80 80 80 80 80 100 100	35 30 30 20 20 15 20 15 15	70 145 165 165 165 165 150 240 240	2 single line + 1 flattening 2 single line + 1 traditional slab reef ²⁾ 2 single line + 2 traditional slab reefs ²⁾		E-1650 E-1800 E-1800 E-1800 E-1800 E-1900 E-2000	E-450 E-650 E-650 E-750 E-750 E-850 E-950	
C245 C242 C264 C261 C285 C280 C304	B171 B172 B199 B200 B232 ⁴⁾ B250 B256 B290	180 180 150 150 170 150 157 150	750 750 750 750 750 750 750 750	135 110 100 175 65 205 115 80	100 100 100 100 80 100 80 100	45 50 15 15 10 15 10 30	200 185 240 240 180 240 180 240	2 single line + 1 traditional slab reefs ²⁾ 2 single line + 1 traditional slab reefs ²⁾ 4 slab reefs		E-1900 E-2000 E-2500 E-2500 E-2500 E-2900	E-850 E-950 E-1100 E-1100 E-1100 E-1550	

1) The "S" measurement includes the shackle supplied by Seldén Mast.
 2) Running Reef Hooks as shown on page 341 should be used for traditional 3rd and 4th slab reefs in conjunction with Single Line Reefs. If permanent reef hooks are used at the tack there is a risk that the sail can snag when a Single Line Reef is shaken out.
 3) "Max height" information refer to forward reef cringle only. Length is calculated on 16-plait reef line. For low stretch lines, reef height may be increased.
 4) Loose footed sails only.

C

5.8 Slab reef - Match booms



Important!

1. The reefing line is tied as illustrated, with a bowline and running noose. No. 1 reef is shown. Note that grommets are required along the foot for each reef.
2. For loose-footed sails, the reef line loop must be held in the correct position along the boom, to ensure proper reefing. Seldén's eye slider can be used for this. (See table 5.13).

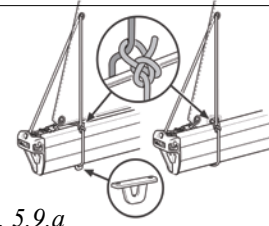
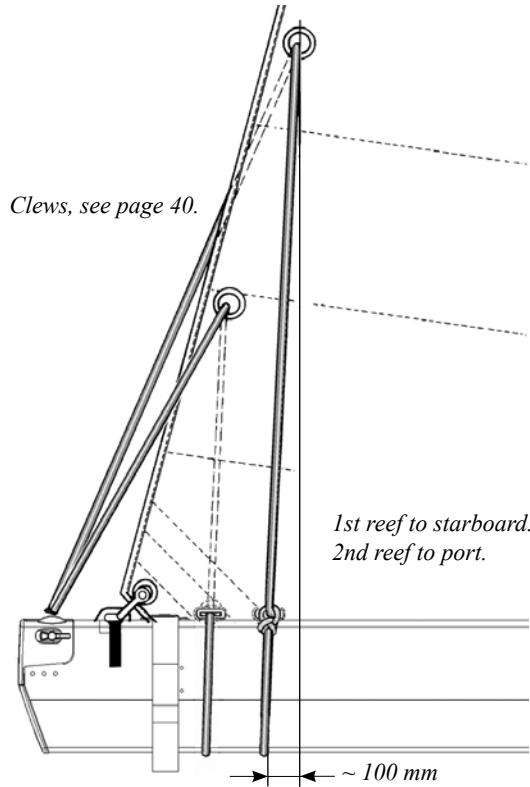

Fig. 5.9.a



Alternatives to cringles.
See figs. 5.12.b and 5.12.c, page 41.

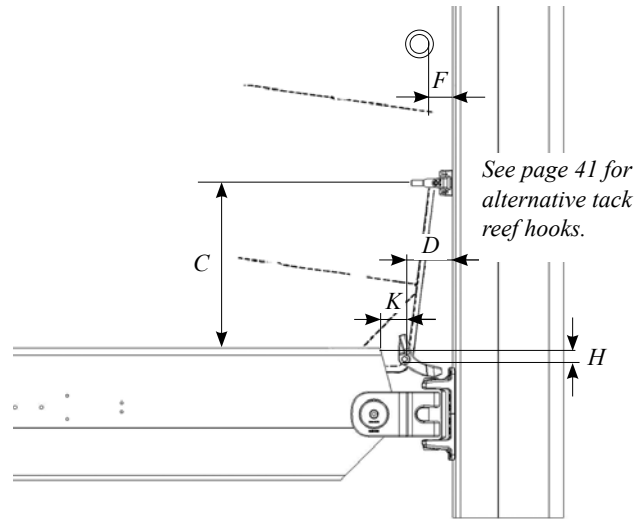

Fig. 5.9.b

Mast section	Boom section	Sail feeder gate "cut-back"			Tack		Reef hooks	No. of internal reefing lines	Reef line attachment at aft end of boom
		C (MDS slides) mm	C (bolt rope) mm	K mm	D mm	H mm	F mm		
C175 C153 C193 C180 C211 C192 C227 C208	B190	100	750	35	80	0	80	2 slab reefs	Reefing line tied around boom; see fig. 5.9.a.
C211 C192 C227 C208 C245 C225	B230	80	750	45	80	20*	80	2 slab reefs	

* Tack shackle below top of extrusion.

5.9 Single line reef Match booms



Important!

1. The reefing line is tied as illustrated, with a bowline and running noose. No. 1 reef is shown. Note that grommets are required along the foot for each reef.
2. For loose-footed sails, the reef line loop must be held in the correct position along the boom, to ensure proper reefing. Seldén's eye slider can be used for this.

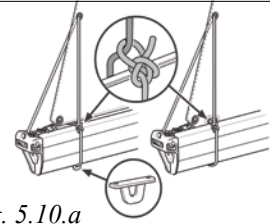

Fig. 5.10.a

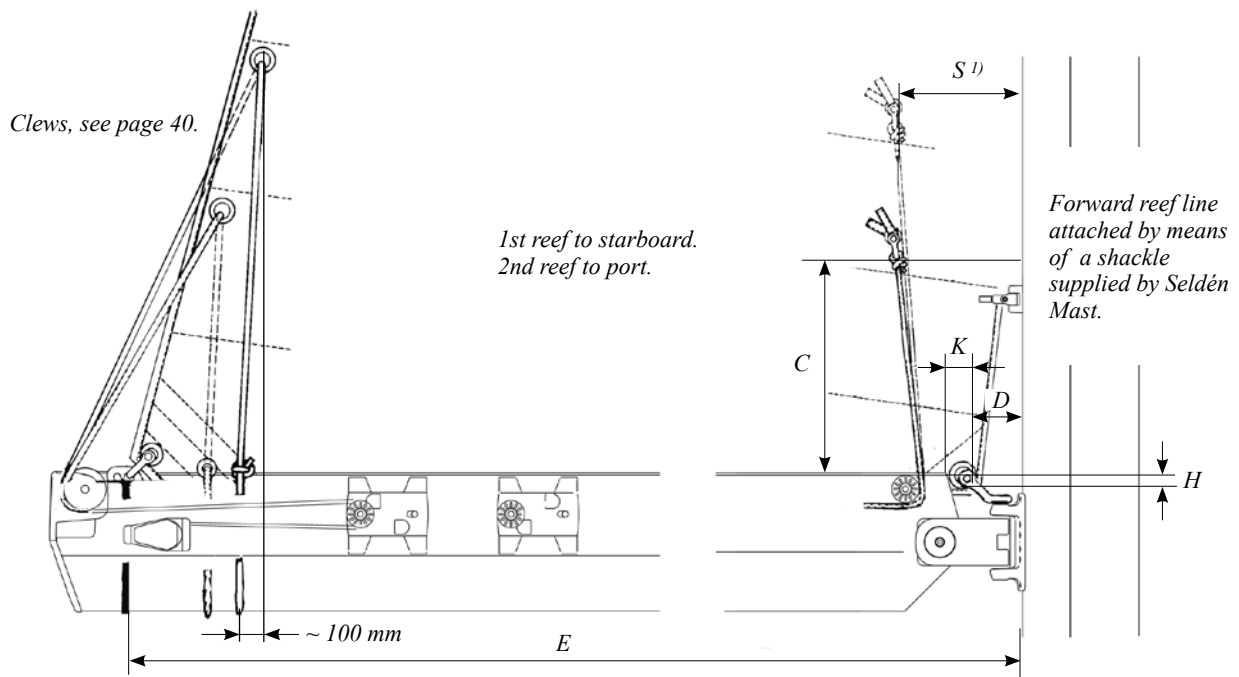

Fig. 5.10.b

Mast section	Boom section	Sail feeder gate "cut-back"			Tack			Single line reef	No. of internal reefing lines	Reef line attachment	Max height for reef 1 (Starboard) ³) mm	Max height for reef 2 (Port) ³) mm
		C (MDS slides) mm	C (bolt rope) mm	K mm	D mm	H mm	S¹) mm					
C175 C153 C193 C180 C211 C192 C227 C208	B190	100	750	35	80	0	180	2 slab reefs	Reefing line tied around boom; see fig. 5.10.a.	E-1650	E-470	
C211 C192 C227 C208 C245 C225	B230	80	750	45	80	20⁴)	195	2 slab reefs		E-1900	E-650	

¹) The "S" measurement includes the shackle supplied by Seldén Mast.

²) Running Reef Hooks as shown on page 41 should be used for traditional 3rd and 4th slab reefs in conjunction with Single Line Reefs. If permanent reef hooks are used at the tack there is a risk that the sail can snag when a Single Line Reef is shaken out.

³) "Max height" information refer to forward reef cringle only. Length is calculated on 16-plait reef line. For low stretch lines, reef height may be increased slightly.

⁴) Tack shackle below top of extrusion.

Comprehensive instructions on Single Line reefs can be obtained from Seldén Mast; reference No 595-664-SET, (in Swedish, English and German).

5.10 Clews, Conventional masts

Outhaul cars or slides are supplied complete with shackles on all current Seldén booms. However, there are older booms from section series P 73/53–137/100 which were supplied without either. In these cases, the sail's clew is lashed to the boom end-fitting.

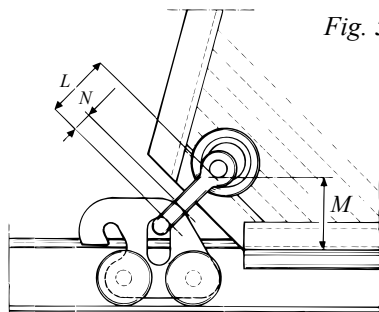

Fig. 5.11.a

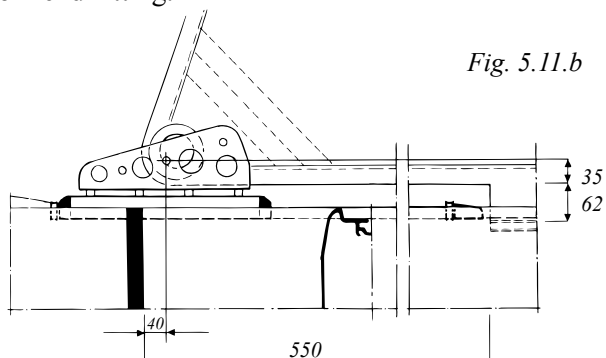

Fig. 5.11.b

Boom			Shackle L	M	N min.
111/81 137/100	507-701		Ø 7 mm key shackle L = 40 mm 307-004	40 mm	11 mm
85/58 86/59	511-519		Ø 5 mm key shackle L = 34 mm 307-001	40 mm	11 mm
111/75 128/90	507-602		Ø 8 mm key shackle L = 44 mm 307-005	45 mm	13 mm
150/105 162/125			Ø 10 mm shackle L = 44 mm 307-024	45 mm	13 mm
189/132 206/139	507-603		Ø 10 mm shackle L = 38 mm 307-024	45 mm	13 mm
B087 B104	507-612		Ø 5 mm shackle L = 38 mm 307-045	35 mm	5 mm
B120 B134 B135	507-519		Ø 8 mm shackle L = 35 mm 307-026	40 mm	8 mm
			Ø 8 mm shackle L = 35 mm 307-026	40 mm	8 mm
143/76	507-569		Ø 8 mm shackle L = 35 mm 307-026	40 mm	10 mm
B152			Ø 8 mm shackle L = 35 mm 307-026	40 mm	10 mm
B153	511-503				
B171	507-569		Ø 10 mm shackle L = 38 mm 307-024	45 mm	10 mm
B172	511-503		Ø 10 mm shackle L = 38 mm 307-024	45 mm	10 mm
B190	507-569		Ø 10 mm shackle L = 38 mm 307-024	45 mm	10 mm
B199	507-503				
B200 B230 B250	511-570		Ø 10 mm shackle L = 38 mm 307-024	50 mm	14 mm
B232 B256	511-508				
B200 B250	511-617		pin Ø 12 x 33 165-402 jaw width: 20 mm	See fig. 5.11.b	
B300	511-588		pin Ø 12 x 37 165-409 jaw width: 23 mm		
B290	511-648		Ø 12 mm shackle L = 41 mm 307-004	55 mm	12 mm

D & E

5.11 Running reef-hooks

”Running” reef-hooks may be used as an alternative to fixed hooks.

C

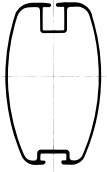
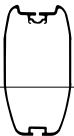
	Boom section	Reef hooks	
		F mm	
	B120	120	See page 30-39 for other tack data.
	B134	120	
	B135	120	
	B143	120	
	B152	120	
	B153	120	
	B171	120	
	B172	120	
	B199	130	
	B200	130	
	B232	130	
	B250	130	
B256	130		
	B290	130	Use "Alternative to cringles second alternative" (Fig. 5.12.c)
	B300		

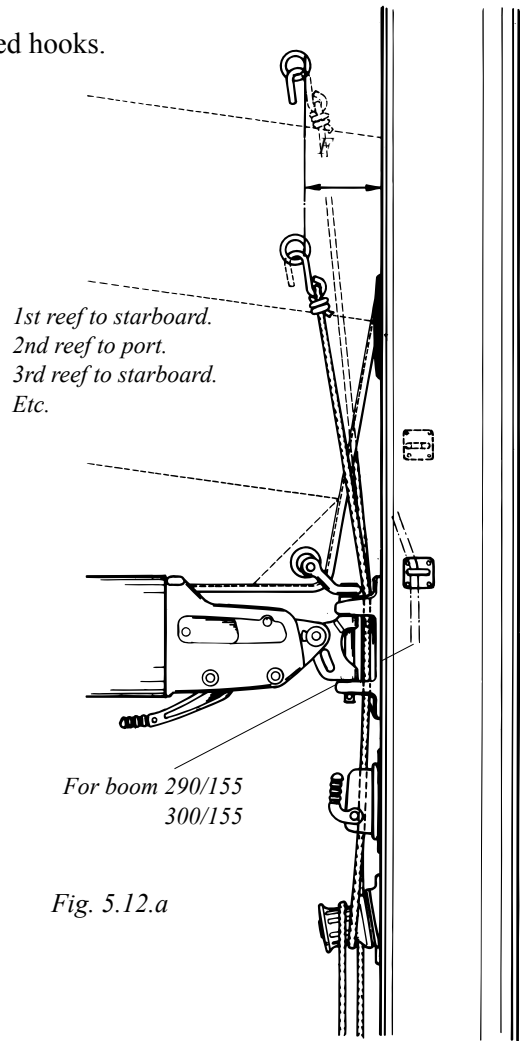

Fig. 5.12.a

Alternatives to cringles

First alternative

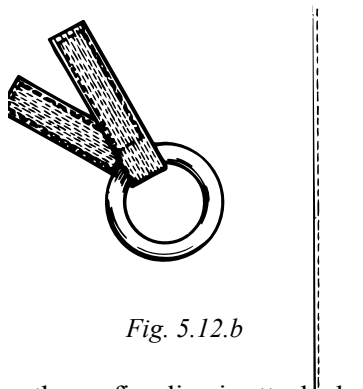

Fig. 5.12.b

Is used when the reefing line is attached with a shackle, such as for ”Single Line Reefing”.

Second alternative

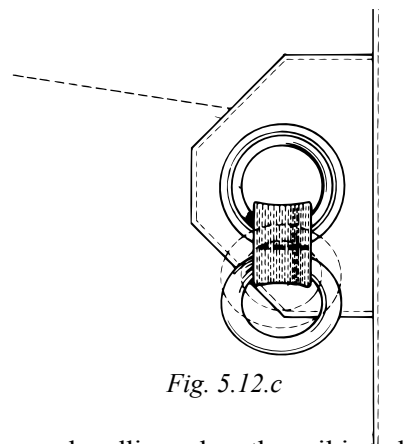
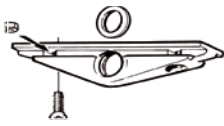
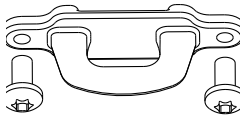

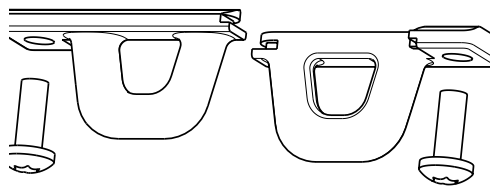



Fig. 5.12.c

Improves handling when the sail is to be reefed to a permanent tack reef-hook.

5.12 Boom sliders - eye

Boom section	T-track width	Part no.	Sliders
86/59 B087 B104	16 mm	511-555-02	<p>Composite slider</p> 
B087 B104	20 mm	511-641-01	<p>Stainless steel slider</p> 
B120 B134 B135 B152 B153 B171 B172	25 mm	511-571-01	<p>Stainless steel slider</p> 
B199 B200 B232 B250 B256 B290 B300	32 mm	511-572-01	
B120 B134 B135 B152 B153 B171 B172 B190	25 mm	511-636-01	<p>Divisible sliders for retro fit directly into the track. (Composite)</p> 
B199 B200 B232 B250 B256 B290 B300 B230	32 mm	511-637-01	 <p>For lazy-jack or reefline location only (not for reefline attachment)</p>

R

6 Furling mast

6.1 R section: manual, hydraulic and electric (1989 - 2002)

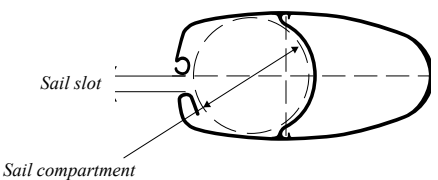
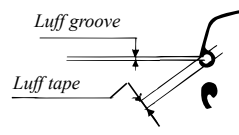
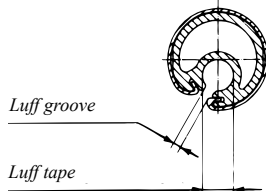
Mast section							Luff extrusion			
										
Mast section	Sail compartment	Sail slot	Max foot length E ³⁾	Spare luff groove in mast			Type	Dia-meter	Luff groove	Max space for luff tape
				Luff groove	Max space available for luff tape	Slide				
mm	mm	mm	mm	mm	mm		mm	mm	mm	
190/94 213/104 235/116	Ø 85 Ø 90 Ø 100	13.5 ± 3	3750 4000 4500	3.25	Ø 7.2	—	RA	Ø 25	2.75 ± 0.25	Ø 6.0
214/122 232/126 260/136	Ø 110 Ø 114 Ø 114	15 ± 3	4750 5500 5500	3.25	Ø 10.0	Bainbridge AO32	RB	Ø 30	3.25 ± 0.35	Ø 8.0 ¹⁾
290/150 324/169 ³⁾	Ø 124 Ø 154	15 ± 3	6000 7000	3.25 4.0	Ø 10.0 Ø 12.0	Bainbridge AO32 Bainbridge AO32 or Rutgerson 101	RC	Ø 38	3.25 ± 0.25	Ø 10 ²⁾
370/192 ³⁾	Ø 174	15 ± 3	7500	3.3	Ø 13.0	Bainbridge AO33 or Rutgerson 102	RD	Ø 58	3.25 ± 0.25	Ø 10

- 1) 1995 and earlier: Ø 10
- 2) Max Ø7 mm luff tape due to new sail feeder (2001).
- 3) When the sail is fully furled, 300 mm of Emax will remain outside the mast due to reinforcement and clew-board. Note! Listed values are MAX VALUES for DACRON® main sails designed primarily for easy furling and reefing. For more performance oriented sails with more shape and stiffer sail cloth, max foot length will be reduced depending on sail design and sail cloth.

□ Design aspects on furling main sails, see page 51.

Alternative clew executions

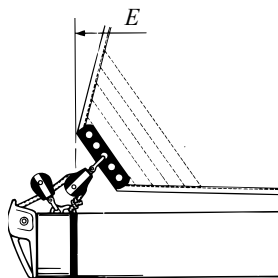

*Clew with clew-board:
Foot ("E") measured to after point of sail.
Clew-board gives longer effective ("E") than integrated block or normal cringle.*

Fig. 6.1.a

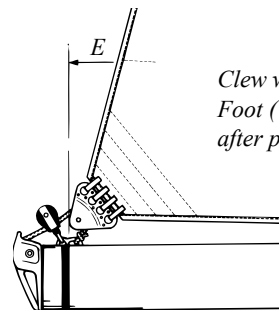

*Clew with integrated block:
Foot ("E") measured to after point of block.*

Fig. 6.1.b



Mast section	A mm	B mm	T mm	
			Boom toggle size	
			80 mm	120 mm
190/94 213/104 235/116	600	400	75	-
214/122 232/126 260/136	650	400	80	125
290/150 324/169	700	500	90	135
370/192	700	500	-	135

Boom section	OS mm
128/90	250
150/105	250
162/125	250
189/132	350
206/139	350
120/62	140
135/72	140
143/76	150
152/84	150
171/94	150
200/117	200*
250/140	200*
300/155	395

For motorised Furling

Red mark(s) may be used to indicate when sail is fully unfurled.

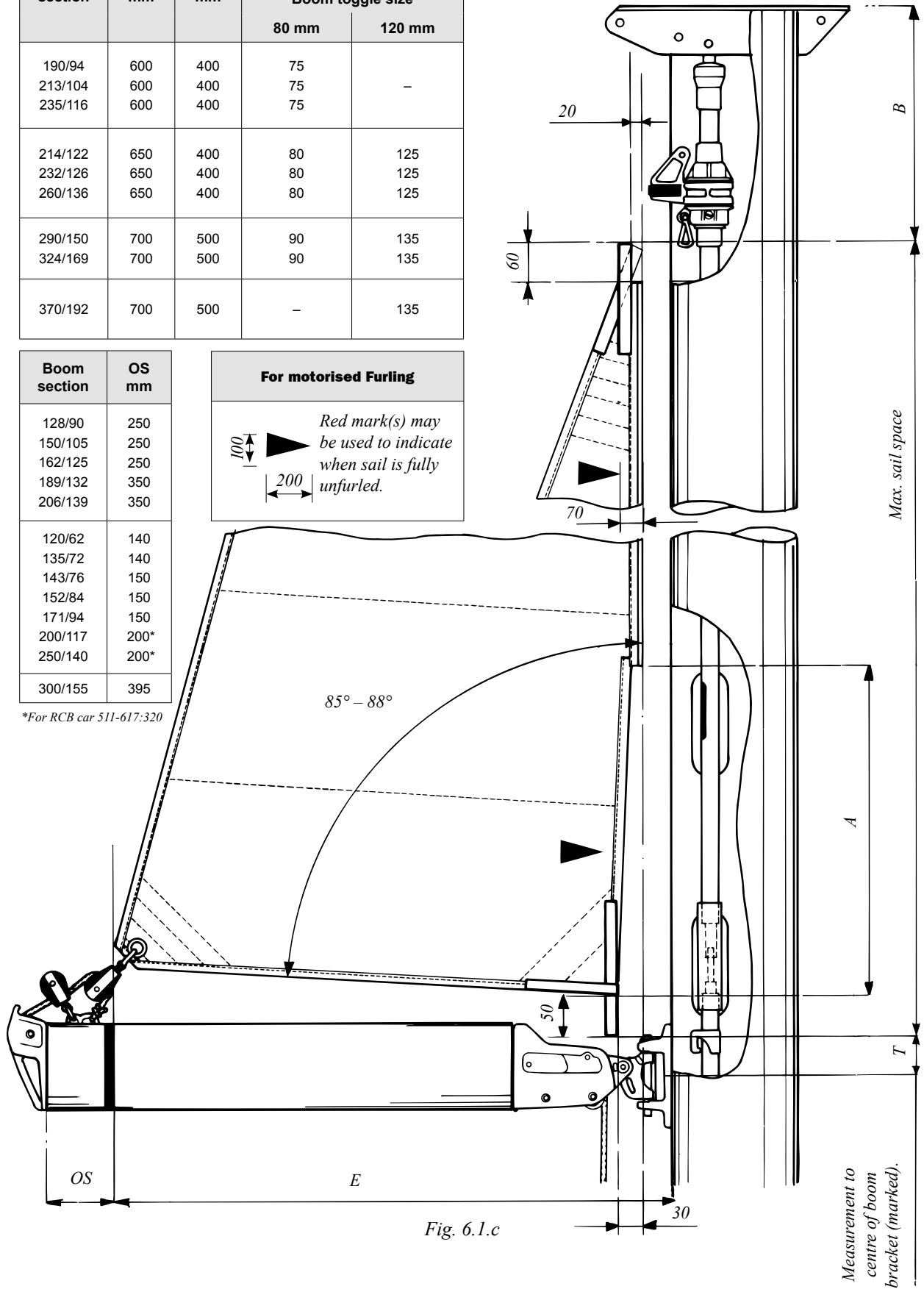

Fig. 6.1.c

Measurement to centre of boom bracket (marked).

*For RCB car 511-617:320

F

6.2 F section: manual, hydraulic and electric (2003 - →)

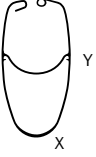
Sections		Section dimm. X/Y mm	I _y cm ⁴	I _x cm ⁴	Wall thickness, mm	Weight kg/m	W _y min cm ³	W _x min cm ³
	F176	176/93	526	187	2.90	4.12	58.2	40.0
	F194	194/101	709	254	3.05	4.69	70.8	49.8
	F212	212/109	970	337	3.15	5.45	88.2	61.8
	F228	228/118	1306	453	3.4	6.30	112	76.8
	F246	246/126	1781	613	3.75	7.37	139	97.3
	F265	265/135	2392	828	4.15	8.66	173	122
	F286	286/146	3237	1122	4.5	10.02	220	154
	F305	305/156	4389	1513	5.05	11.75	276	194
	F324	324/169	5576	2056	5.5	13.8	329	243
	F370	370/192	8835	3149	5.8	16.6	468	326
F406	408/207	14321	4725	6.5	19.34	671	451	

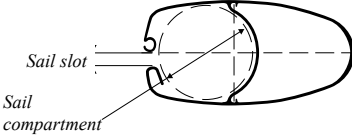
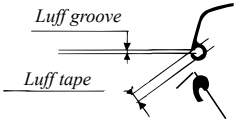
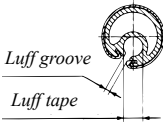
Mast section								Luff extrusion			
											
Section	Sail compartment mm	Max foot length E ¹⁾ mm		Sail slot mm	Spare luff groove in mast			Type	Dia-meter mm	Luff groove mm	Max space for luff tape mm
		Type	mm		Luff groove mm	Max space available for luff tape mm	Slide				
F176	Ø 85	RA	3750	15±3	3.25±0.25	6	-	RA	Ø 25	2.75±0.25	Ø 6
F194	Ø 93	RA	4200								
F212	Ø 100	RA	4500								
		RB	4400								
F228	Ø 108	RA	5000	17±3	3.25±0.25	8	Bainbridge AO31	RB	Ø 30	3.25±0.35	Ø 8
		RB	4900								
F246	Ø 114	RB	5400								
F265	Ø 123	RB	6000								
		RC	5800								
F286	Ø 133	RB	6500	20±3	4±0.25	10	Bainbridge AO32	RC	Ø 38	3.25±0.35	Ø 7 ²⁾
		RC	6300								
F305	Ø 141	RB	6900								
		RC	6700								
F324	Ø 154	RC	7000	22±3	4±0.25	12	Bainbridge AO32	RD	Ø 58	3.25±0.35	Ø 10
		RD	7000								
F370	Ø 174	RC	7500								
		RD	7500								
F406	Ø 190	RD	9500	24±3	6.5±0.5	15	Bainbridge AO33				

1) When the sail is fully furled, min 300 mm of E_{max} will remain outside the mast due to reinforcement and clew-board. Note! Listed values are MAX VALUES for DACRON® main sails designed primarily for easy furling and reefing. For more performance oriented sails with more shape and stiffer sail cloth, max foot length will be reduced depending on sail design and sail cloth.

□ Design aspects on furling main sails, see page 51.

Alternative clew executions

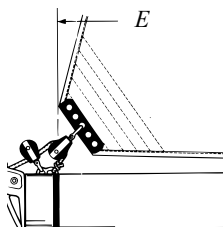

Clew with clew-board:
Foot ("E") measured to after point of sail.
Clew-board gives longer effective ("E") than integrated block or normal cringle.

Fig. 6.2.a

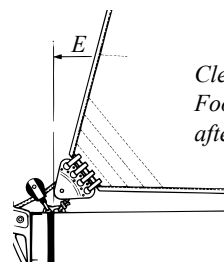

Clew with integrated block:
Foot ("E") measured to after point of block.

Fig. 6.2.b

F

Mast section	RA			RB			RC			RD		
	A	B	T	A	B	T	A	B	T	A	B	T
F176	600	400	80									
F194	600	400	80									
F212	600	400	80	650	400	80						
F228	600	400	80	650	400	80						
F246				650	400	80						
F265				650	400	125	700	500	130			
F286				650	400	125	700	500	130			
F305				650	400	125	700	500	130	700	500	135
F324										700	500	135
F370										700	500	135
F406										700	500	175

Boom section	OS mm
B120	140
B134	140
B135	140
B143	150
B152	150
B153	150
B171	150
B172	150
B199	200
B200	200*
B232	285
B250	200*
B256	310
B290	360
B300	395
B380	430

For motorised Furling

Red mark(s) may be used to indicate when sail is fully unfurled.

*For RCB car 511-617:320

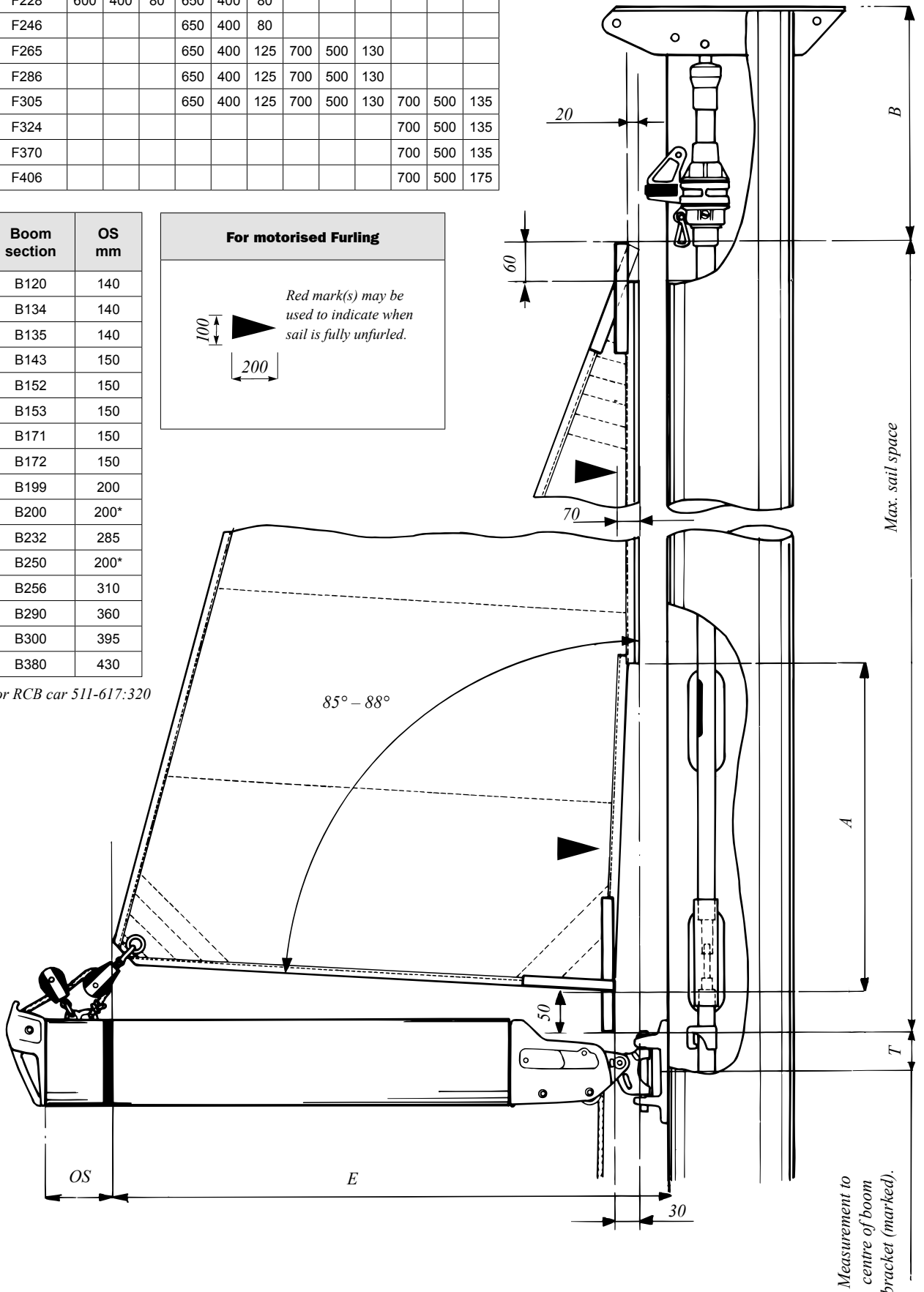
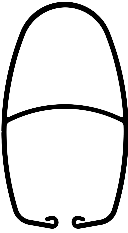
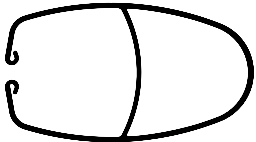
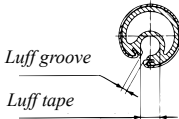

Fig. 6.2.c

6.3 F section: 2017→

Sections	Section dimn. X/Y mm	ly cm4	lx cm4	Wall thickness sides	Weight kg/m -0 +20%	Wy cm3	Wx cm3	Type	
	F170	170/95	441	187	2,90	3,84	50,9	39	RA
	F185	185/104	591	252	3,05	4,36	62,3	48,5	RA
	F199	199/113	797	337	3,25	5,02	78,2	60	RA (RB)
	F217	217/123	1070	455	3,40	5,71	96,9	74,3	RB
	F234	234/131	1466	615	3,88	6,74	122	94	RB
	F252	252/142	1946	828	4,30	7,76	153	117	RB, RC
	F272	272/153	2656	1122	4,77	9,06	192	147	RC
	F291	291/163	3598	1515	5,34	10,67	243	187	RC

Mast section					Luff extrusion			
								
Section	Sail compartment	Max foot length E ¹⁾		Sail slot	Type	Dia-meter	Luff groove	Max space for luff tape
	mm	Type	mm	mm	mm	mm	mm	mm
F170	ø85	RA	3750	15+ -2.5	RA	ø 25	2.75±0.25	ø 6
F185	ø93	RA	4200		RB	ø 30	3.25±0.35	ø 8
F199	ø100	RA	4500		RC	ø 38		ø 7 ²⁾
F199		RB	4400		RD			
F217	ø108	RA	5000		17 + -3	RC	ø 38	ø 7 ²⁾
F217		RB	4900					
F234	ø114	RB	5400	RC		ø 38	ø 7 ²⁾	
F252	ø123	RB	6000	RD				ø 58
F252		RC	5800	RC		ø 38	ø 7 ²⁾	
F272	ø133	RB	6500					
F272		RC	6300					
F291	ø143	RC	6700	RD	ø 58	ø 10		
		RD	6000					

1) When the sail is fully furled, min 300 mm of Emax will remain outside the mast due to reinforcement and clew-board. Note! Listed values are MAX VALUES for DACRON® main sails designed primarily for easy furling and reefing. For more performance oriented sails with more shape and stiffer sail cloth, max foot length will be reduced depending on sail design and sail cloth.

□ Design aspects on furling main sails, see page 51.

Alternative clew executions

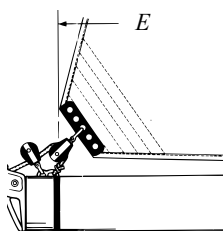

Clew with clew-board:
Foot ("E") measured to after point of sail.
Clew-board gives longer effective ("E") than integrated block or normal cringle.

Fig. 6.2.a

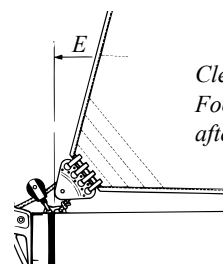

Clew with integrated block:
Foot ("E") measured to after point of block.

Fig. 6.2.b

F

Mast section	RA			RB			RC			RD		
	A	B	T	A	B	T	A	B	T	A	B	T
F170	600	400	80									
F185	600	400	80									
F199	600	400	80	650	400	80						
F217	600	400	80	650	400	80						
F234				650	400	80						
F252				650	400	125	700	500	130			
F272				650	400	125	700	500	130			
F291							700	500	130	700	500	135

Boom section	OS mm
B120	140
B134	140
B135	140
B143	150
B152	150
B153	150
B171	150
B172	150
B199	200
B200	200*
B232	285
B250	200*
B256	310
B290	360
B300	395
B380	430

For motorised Furling

Red mark(s) may be used to indicate when sail is fully unfurled.

*For RCB car 511-617:320

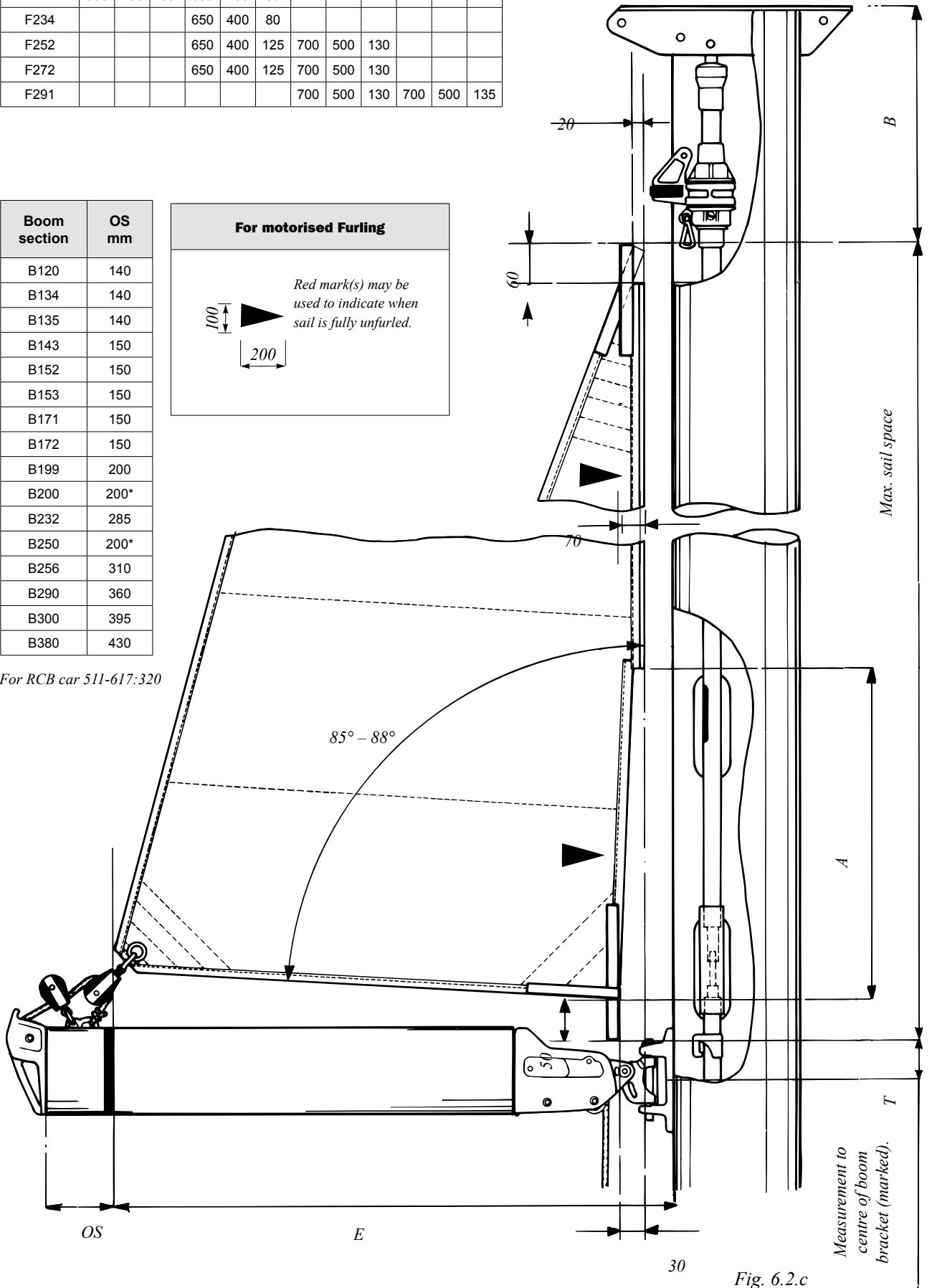
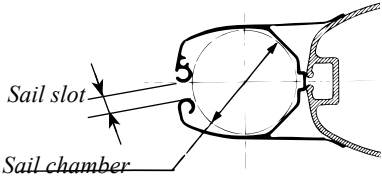
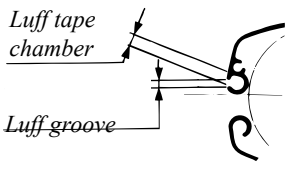

Fig. 6.2.c

6.4 Furlex Main - Retro-fit system

(Production of this product range discontinued 2003).

Furlex Main – Other section				Luff extrusion						
										
Furlex Main Type	Sail chamber	Sail slot	Max. foot length recommended ¹⁾ "E"	Spare luff groove in mast			Type	Dia-meter	Luff groove	Max space for luff tape
				Luff groove	Max space available for luff tape	Slide				
mm	mm	mm	mm	mm	mm	mm	mm	mm	mm	
Type 76 Type 90	Ø 76 Ø 90	13.5 ± 3	3500 4000	3.25 3.25	Ø 9.4 Ø 9.4	Bainbridge AO31 or Rutgerson 101	RA	Ø 25	2.75 ± 0.25	Ø 6.0
Type 108	Ø 108	15 ± 3	5000	3.25	Ø 10.0	Bainbridge AO32 or Rutgerson 101	RB	Ø 30	3.25 ± 0.35	Ø 8*

¹⁾ Note! Listed values are MAX VALUES for DACRON® main sails designed primarily for easy furling and reefing. For more performance oriented sails with more shape and stiffer sail cloth, max foot length will be reduced depending on sail design and sail cloth.

*1995 and earlier: Ø 10

- The luff extrusion is asymmetrically shaped in order to help overcome initial resistance when starting to furl. Do not use heavy sail-cloth in the luff area.
- Head and tack webbing bands should be of soft quality which can fold easily. 20 mm is a suitable width. Do not use metal cringles on them.
- Battens must be located on the port side of the sail so as not to snag on the inside of the sail compartment.
- If clew cringles are used they must not be thicker than 14 mm in order to fit the outhaul block.
- The upper part of the luff extrusion will be kept centered by the halyard swivel, while most of the section will rest on the aft face of the sail compartment when sailing. The luff curve must have a wedge formed into it for compensation (0 to 30 mm) at the upper 500–800 mm of the luff.

Alternative clew executions

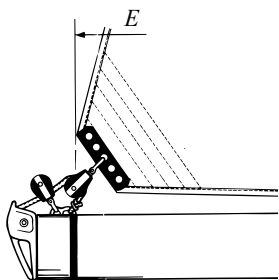

Clew with clew-board:
Foot ("E") measured to after point of sail.
Clew-board gives longer effective ("E") than integrated block or normal cringle.

Fig. 6.3.a

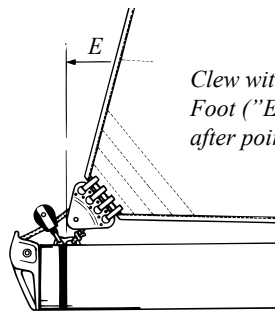

Clew with integrated block:
Foot ("E") measured to after point of block.

Fig. 6.3.b

Furlex-Main Type	A	B	T	OS
76	600	270	60	180
90	600	270	60	180
108	650	270	65	260

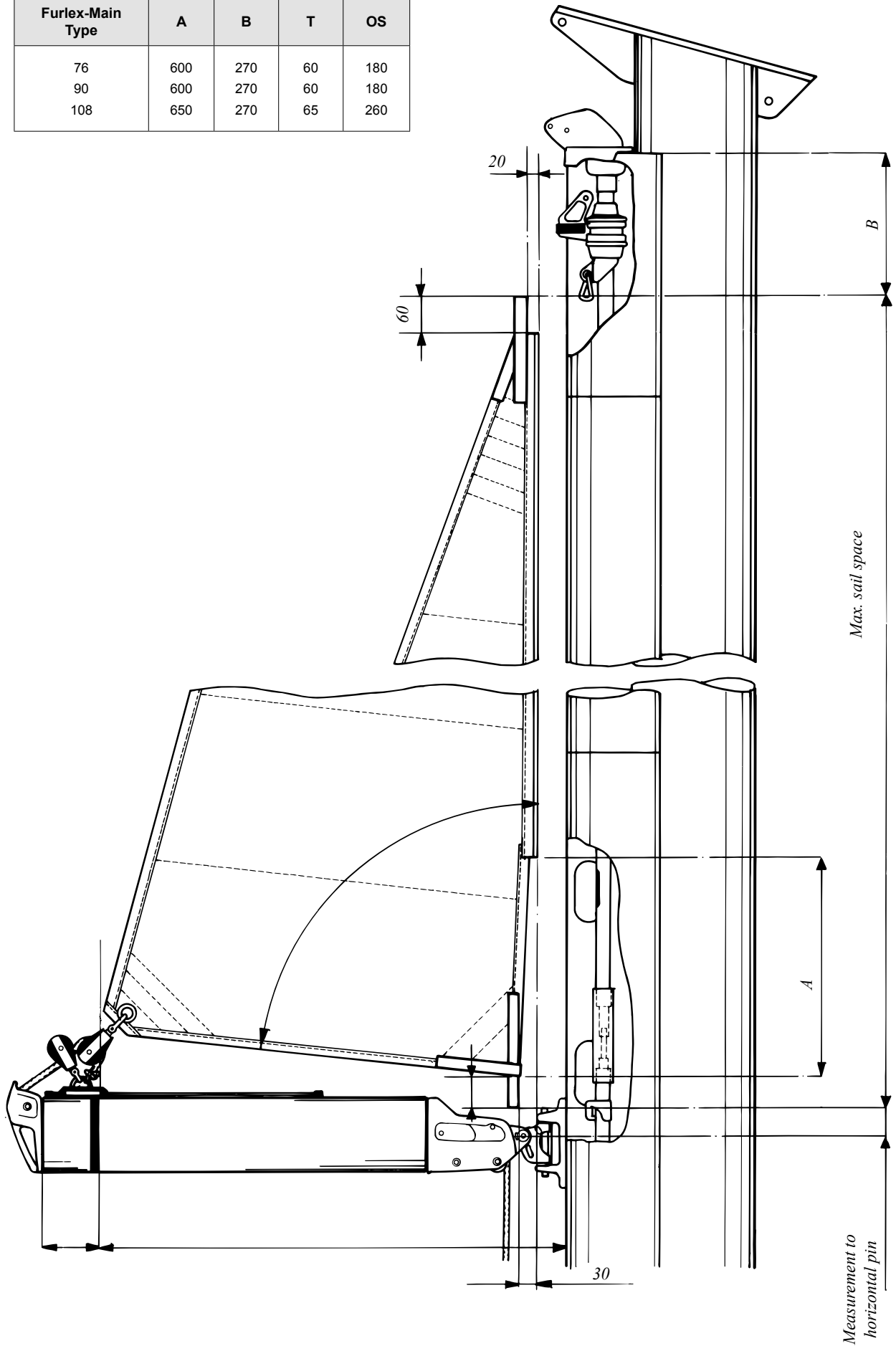

Fig. 6.3.c

6.5 Design aspects on furling mast main sails

Sail cloth type

In general, single layer cloth (e.g. Dacron™) folds easier around the luff extrusion than multi-layer laminate cloth, causing less furling resistance. "Softer" sail cloth therefore allows more sail to be furled into the mast. Sail cloth generally becomes softer with time, so a new sail can cause more furling resistance than a sail that has been used for some time.

Sail cloth disposition

The luff extrusion is asymmetrically shaped in order to help overcome initial resistance when starting to furl. Do not use heavy sail cloth in the luff area.

Clew height

A furling main sail foot should rise towards the clew, approximately 85°–88° (see e.g. fig. 6.2.c). This increases leech tension when furling and prevents the lower part of the sail roll becoming too bulky. Note that when the sail is furled, the weight of the sail may cause the clew to move downwards.

Luff curve shape

The upper part of the luff extrusion will be kept centered by the top swivel, while most of the luff extrusion will rest on the aft face of the sail compartment when sailing. The luff curve must have a wedge formed into it for compensation (0- to 30 mm) at the upper 500 – 800 mm of the luff.

Clew reinforcement

The clew reinforcement should be made so that it allows the sail to be furled in leaving approximately 300 – 500 mm outside the mast.

Webbing tape

Head and tack webbing tapes should be of soft quality which can fold easily. Do not use cringles.

Luff tape

Avoid using luff tape close to head and tack. The high loads in head and tack may damage the luff tape. (See e.g. fig. 6.2.c)

Clew cringles

If clew cringles are used they must not be thicker than 14 mm in order to fit the outhaul block.

Batten types

The main batten types used in furling main sails are: full-length vertical battens, short vertical battens and horizontal (foldable) battens. Experience has shown that vertical battens work very well whereas horizontal battens have a tendency to snag in the sail slot when the sail is furled out.

If full-length vertical battens are used, round battens generally work better than square battens since square battens can twist. If short vertical battens are used, square battens often work well and are usually less bulky.

Batten location

Battens must be located on the port side of the sail so as not to snag on the inside of the sail compartment.

End fittings, connectors and tensioning arrangement

End fittings, connectors and tensioning arrangement (vertical battens) should be made as slim as possible. Bulky solutions may cause the battens to snag in the sail slot.

Short vertical battens – vertical displacement

Short vertical battens should be located so that they do not overlap each other vertically. The lowest batten should not overlap the clew reinforcement.

7 Furlex -Seldén jib furling and reefing system

7.1 Furlex, 20S-40S

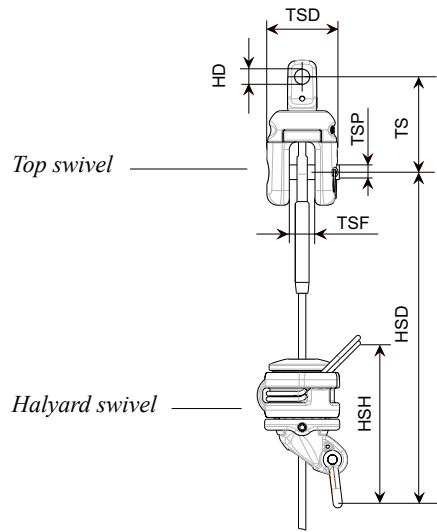

As Furlex 20S, 30S and 40S has no luff extrusion these models are not suitable for reefing.

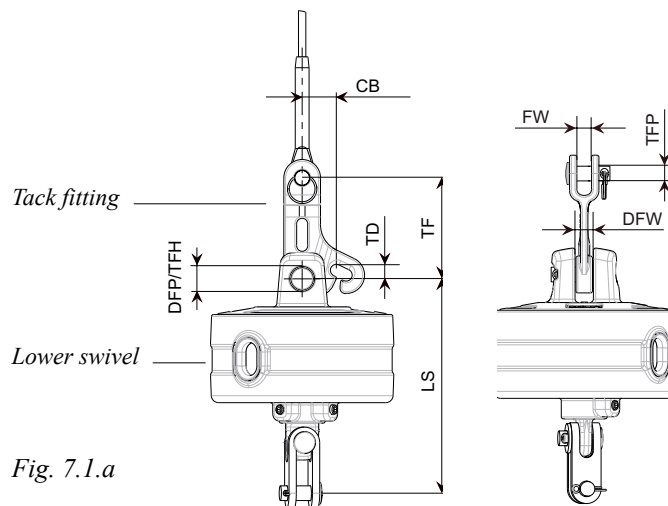

Fig. 7.1.a

Fig. 7.1.b

Measurement	Code	Furlex 20S	Furlex 30S	Furlex 40S
Top Swivel Height	TS	35	52	52
Top Swivel Diameter	TSD	Ø 26	Ø 39	Ø 39
Top Swivel Pin	TSP	Ø 6	Ø 8	Ø 8
Top Swivel Fork	TSF	10	14	14
Upper Hole Dia	HD	Ø 5,5	Ø 8,5	Ø 8,5
Halyard Swivel Height	HSH	-	90	90
Halyard Swivel Deduction	HSD	-	180	180
Tack Fitting height	TF	-	55	55
Tack Fitting Fork Width	FW	-	8	8
Tack Fitting Pin	TFP	-	Ø 8	Ø 8
Tack Fitting Hole	TFH	-	Ø 8,5	Ø 8,5
Cut Back	CB	-	20	20
Tack Deduction	TD	-	10	10
Lower Swivel Height	LS	60	106	117
Drum Fork Width	DFW	9	10	10
Drum Fork Pin	P	5,8	8	8

7.2 Furlex 50S-500S

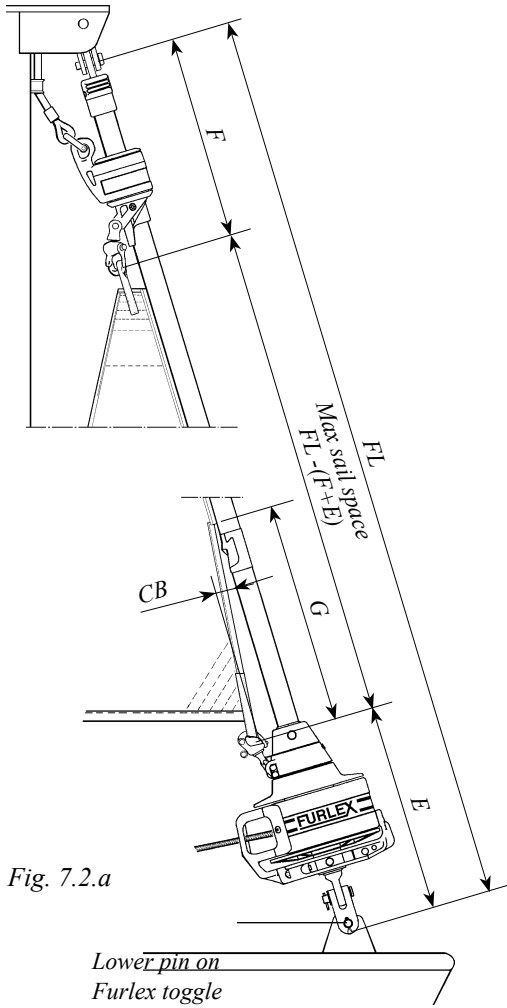

Fig. 7.2.a



Sails with a luff considerably shorter (more than 500 mm) than the maximum permissible must be fitted with a permanent head pendant. The total luff length including pendant should be just less than the "Max. sail space" dimension. A too short luff length (including head pendant) can result in "halyard wrap" which may cause severe damage to the forestay, and put the entire rig at risk. For more information please refer to "Sail information" in the relevant Furlex manual.

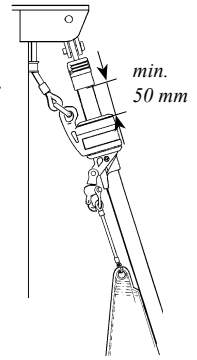

Fig. 7.2.b



Furlex 400S Mk2 halyard swivel.

If "F" measurement is > specified (sail is made too short) there is a risk of the halyard shackle shafing the luff extrusion.

Always check clearance. Add a pendant between sail and halyard swivel or a soft shackle between HMPE loop in the halyard swivel and the halyard shackle. A too short luff length (including head pendant) can also result in "halyard wrap" which may cause severe damage to the forestay, and put the entire rig at risk. For more information please refer to "Sail information" in the relevant Furlex manual.

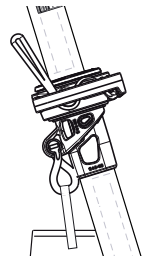

Fig. 7.3.c

Furlex 50S

Furlex 100S - 500S

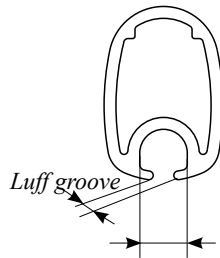

Fig. 7.2.c

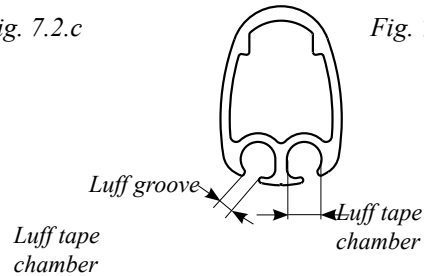
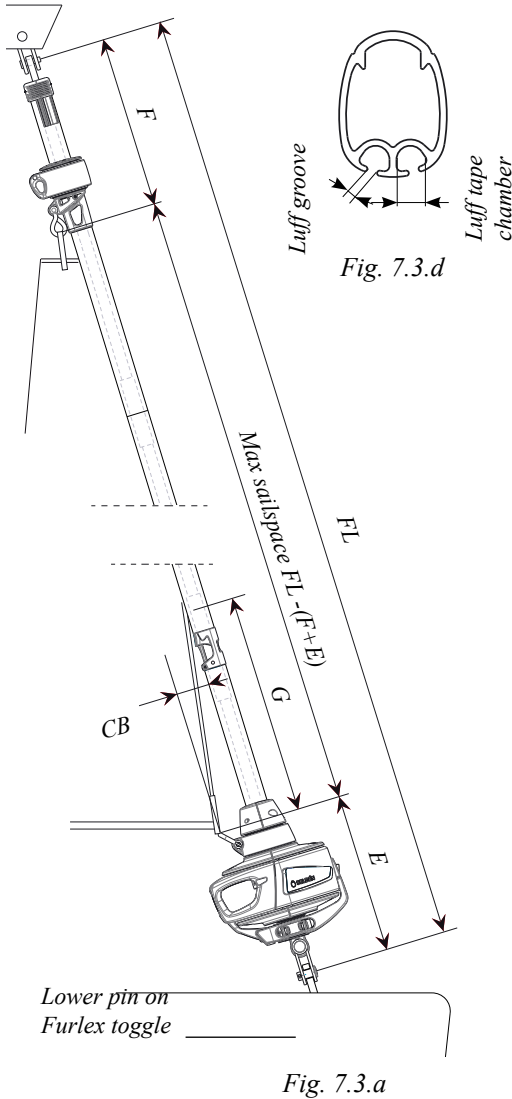

Fig. 7.2.d

Furlex Type/Serie	Section dimension	Luff groove mm	Max. space available in chamber mm	Max. luff tape mm	Cut-back CB mm	Cut-back height G mm	Maximum sail space FL-(F+E) (Measurement calculated from existing forestay length: FL).			
							F mm	E mm	F+E mm	
Manual	A	26/17	3.0	∅ 6	∅ 5	60	1100	360	280	640
	B	31/20	3.0	∅ 6	∅ 5	60	1100	390	340	730
	C	40/27	3.0	∅ 7	∅ 6	80	1100	540	420	960
	D	50/34	3.0	∅ 8	∅ 6	100	1100	620	490	1110
	50S	22/15	2.6	∅ 6	∅ 5	25	630	360	215	575
	100S ∅ 4 & 5	26/17	3.0	∅ 6	∅ 5	60	1100	410	280	690
	100S ∅ 6	26/17	3.0	∅ 6	∅ 5	60	1100	425	295	720
	200S	31/21	3.0	∅ 6	∅ 5	60	1100	540	330	870
	300S ∅ 8	39/27	3.0	∅ 7.5	∅ 6.5	80	1100	550	400	950
	300S ∅ 10	39/27	3.0	∅ 7.5	∅ 6.5	80	1100	650	400	1050
	400S	48/34	3.0	∅ 8	∅ 6.5	95	1100	620	535	1155
500S	60/46	3.0	∅ 9	∅ 7	95	1100	670	535	1205	

This data is also valid for Furlex Electric.

7.3 Furlex 104S-404S (2014-) & Furlex Electric (2018-)



Sails with a luff considerably shorter (more than 500 mm) than the maximum permissible must be fitted with a permanent head pendant. The total luff length including pendant should be just less than the "Max. sail space" dimension.

A too short luff length (including head pendant) can result in "halyard wrap" which may cause severe damage to the forestay, and put the entire rig at risk. For more information please refer to "Sail information" in the relevant Furlex manual.

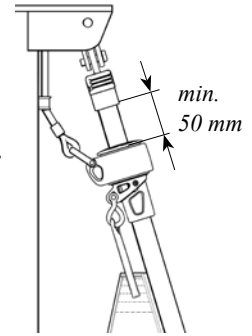

Fig. 7.3.b



Furlex 104S/204S Mk2/304S Mk2/404S halyard swivel.

If "F" measurement is > specified (sail is made too short) there is a risk of the halyard shackle shafing the luff extrusion.

Always check clearance. Add a pendant between sail and halyard swivel or a soft shackle between HMPE loop in the halyard swivel and the halyard shackle. A too short luff length (including head pendant) can also result in "halyard wrap" which may cause severe damage to the forestay, and put the entire rig at risk. For more information please refer to "Sail information" in the relevant Furlex manual.

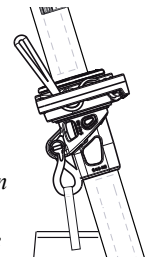

Fig. 7.3.c

Furlex Type/Serie	Section dimension	Luff groove mm	Max. space available in chamber mm	Max. luff tape mm	Cut-back CB mm	Cut-back height G mm	Maximum sail space FL-(F+E) (Measurement calculated from existing forestay length: FL).			
							F mm	E mm	F+E mm	
Manual	104S Ø 4 & 5	30/20	2.75	Ø 6	Ø 5	60	1100	440	205	645
	104S Ø 6	30/20	2.75	Ø 6	Ø 5	60	1100	440	220	660
	204S Ø 6	35/25	3.0	Ø 6	Ø 5	60	1100	425	265	690
	204S Ø 7	35/25	3.0	Ø 6	Ø 5	60	1100	425	265	690
	204S Ø 8	35/25	3.0	Ø 6	Ø 5	60	1100	425	275	700
	304S Ø 8	42/31	3.0	Ø 7	Ø 6.5	60	1100	430	310	740
	304S Ø 10	42/31	3.0	Ø 7	Ø 6.5	60	1100	530	315	845
	404S Ø 12	52/38	3.0	Ø 8	Ø 6.5	80	1100	630	390	1020
404S Ø 14	52/38	3.0	Ø 8	Ø 6.5	80	1100	630	410	1040	

Head deduction (F) Furlex 204S-304S Mk2 Halyard swivel (2018-)

Furlex type	F	F+E
204S Ø 6	485	750
204S Ø 7	485	750
204S Ø 8	485	760
304S Ø 8	490	800
304S Ø 10	490	905

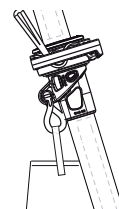

Fig 7.3.d

7.4 Furlex 200TD-400TD (Through Deck)

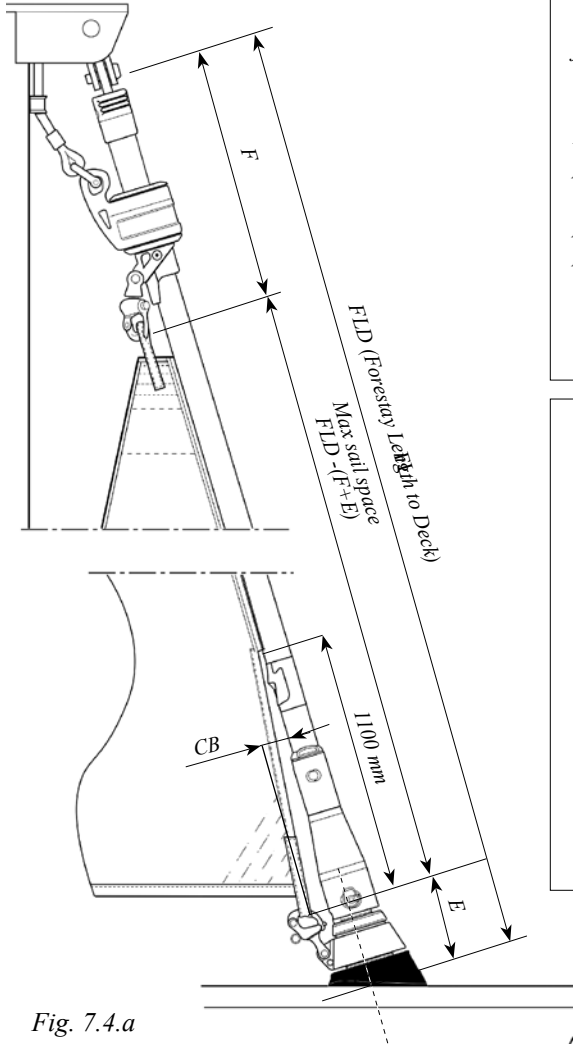

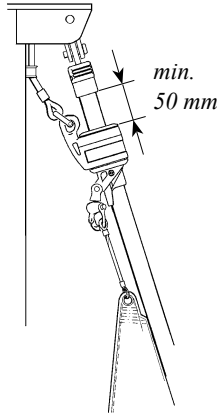



Fig. 7.4.a





Sails with a luff considerably shorter (more than 500 mm) than the maximum permissible must be fitted with a permanent head pendant. The total luff length including pendant should be just less than the "Max. sail space" dimension. A too short luff length (including head pendant) can result in "halyard wrap" which may cause severe damage to the forestay, and put the entire rig at risk. For more information please refer to "Sail information" in the relevant Furlex manual.

Fig. 7.4.b



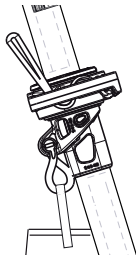

Furlex 400TD Mk2 halyard swivel.

If "F" measurement is >specified (sail is made too short) there is a risk of the halyard shackle shafing the luff extrusion. Always check clearance. Add a pendant between sail and halyard swivel or a soft shackle between HMPE loop in the halyard swivel and the halyard shackle. A too short luff length (including head pendant) can also result in "halyard wrap" which may cause severe damage to the forestay, and put the entire rig at risk. For more information please refer to "Sail information" in the relevant Furlex manual.

Fig. 7.4.c

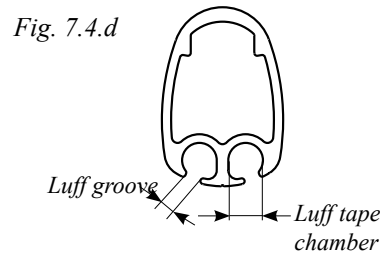

Fig. 7.4.d

Furlex Type/Serie		Section dimension	Luff groove	Luff tape chamber	Max. luff tape	Cut-back CB mm	Maximum sail space FLD-(F+E)		
			mm	mm	mm		F mm	E mm	F+E mm
Manual	200TD	31/21	3.0	Ø 6	Ø 5	60	540	130	670
	300TD Ø 8	39/27	3.0	Ø 7.5	Ø 6.5	80	550	150	700
	300TD Ø 10	39/27	3.0	Ø 7.5	Ø 6.5	80	650	150	800
	400TD	48.5/34	3.0	Ø 8	Ø 6.5	95	620	210	830

This data is also valid for Furlex TD Electric.

7.5 Furlex 204/304/404TD (Through Deck)

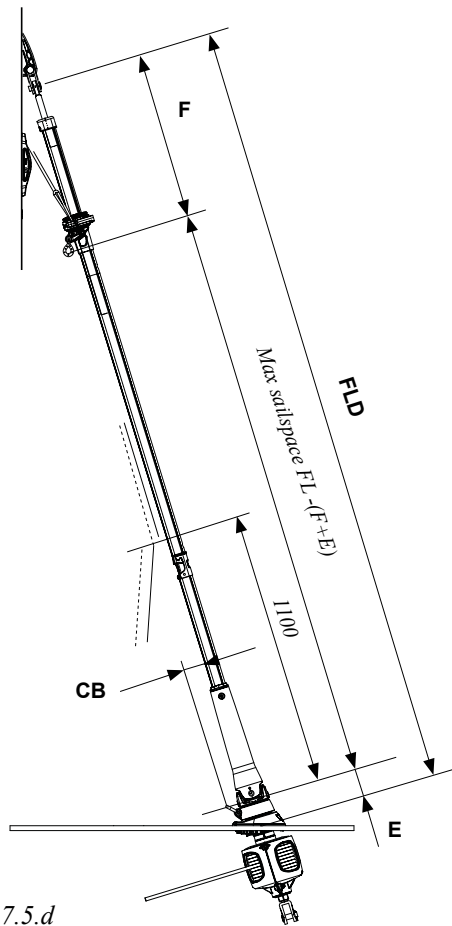

Fig. 7.5.d



If "F" measurement is >specified (sail is made too short) there is a risk of the halyard shackle shafing the luff extrusion.

Always check clearance. Add a pendant between sail and halyard swivel or a soft shackle between HMPE loop in the halyard swivel and the halyard shackle. A too short luff length (including head pendant) can also result in "halyard wrap" which may cause severe damage to the forestay, and put the entire rig at risk. For more information please refer to "Sail information" in the relevant Furlex manual.

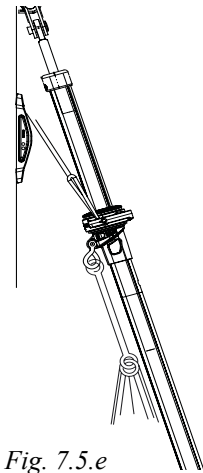
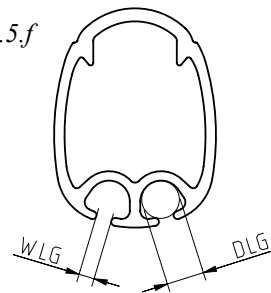

Fig. 7.5.e

Fig. 7.5.f



Furlex Type/Serie	Section dimension	Luff groove mm	Luff tape chamber mm	Max. luff tape mm	Cut-back CB mm	Maximum sail space FLD-(F+E)			
						F mm	E mm	F+E mm	
Manual	204TD	35x25	3.0	Ø 6	Ø 5.5	60	485	75	560
	304TD Ø 8	42x31	3.0	Ø 7	Ø 6.5	60	490	85	575
	304TD Ø 10	42x31	3.0	Ø 7	Ø 6.5	60	590	85	675
	404TD	52x38	3.0	Ø 8	Ø 7,5	80	630	115	745

This data is also valid for Furlex TD Electric.

7.6 Furlex Hydraulic 300H-500H

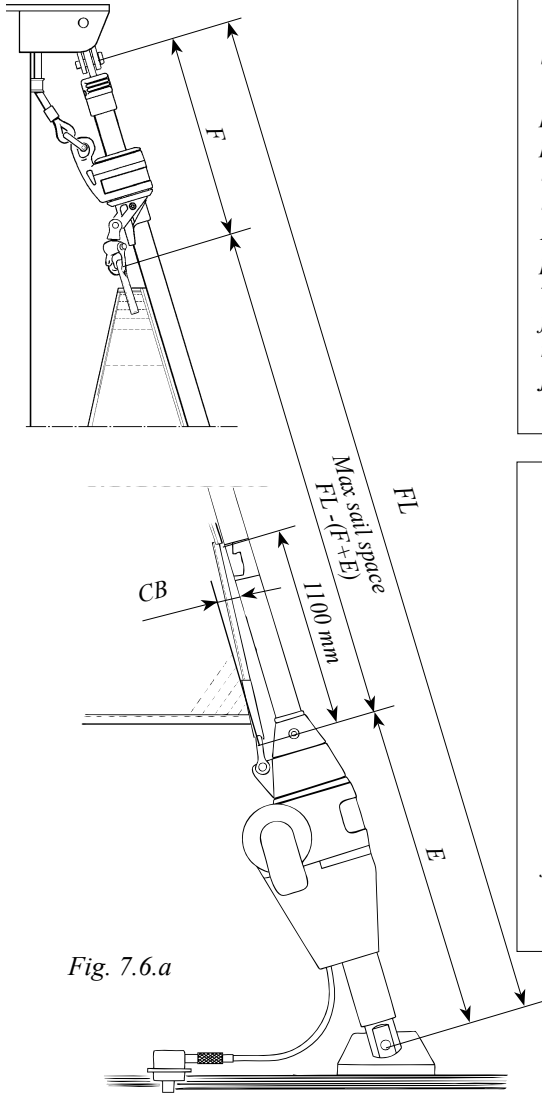

Fig. 7.6.a



Sails with a luff considerably shorter (more than 500 mm) than the maximum permissible must be fitted with a permanent head pendant. The total luff length including pendant should be just less than the "Max. sail space" dimension. A too short luff length (including head pendant) can result in "halyard wrap" which may cause severe damage to the forestay, and put the entire rig at risk. For more information please refer to "Sail information" in the relevant Furlex manual.

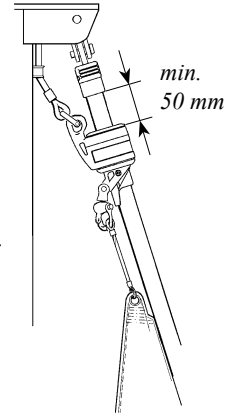

Fig. 7.6.b



Furlex 400H Mk2 halyard swivel.

If "F" measurement is > specified (sail is made too short) there is a risk of the halyard shackle shafing the luff extrusion.

Always check clearance. Add a pendant between sail and halyard swivel or a soft shackle between HMPE loop in the halyard swivel and the halyard shackle. A too short luff length (including head pendant) can also result in "halyard wrap" which may cause severe damage to the forestay, and put the entire rig at risk. For more information please refer to "Sail information" in the relevant Furlex manual.

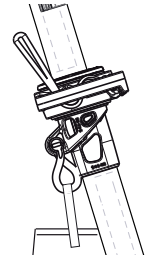

Fig. 7.6.c

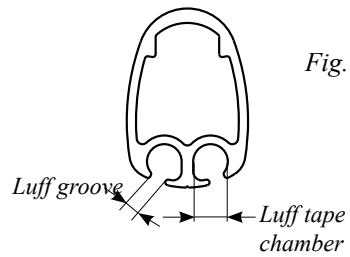
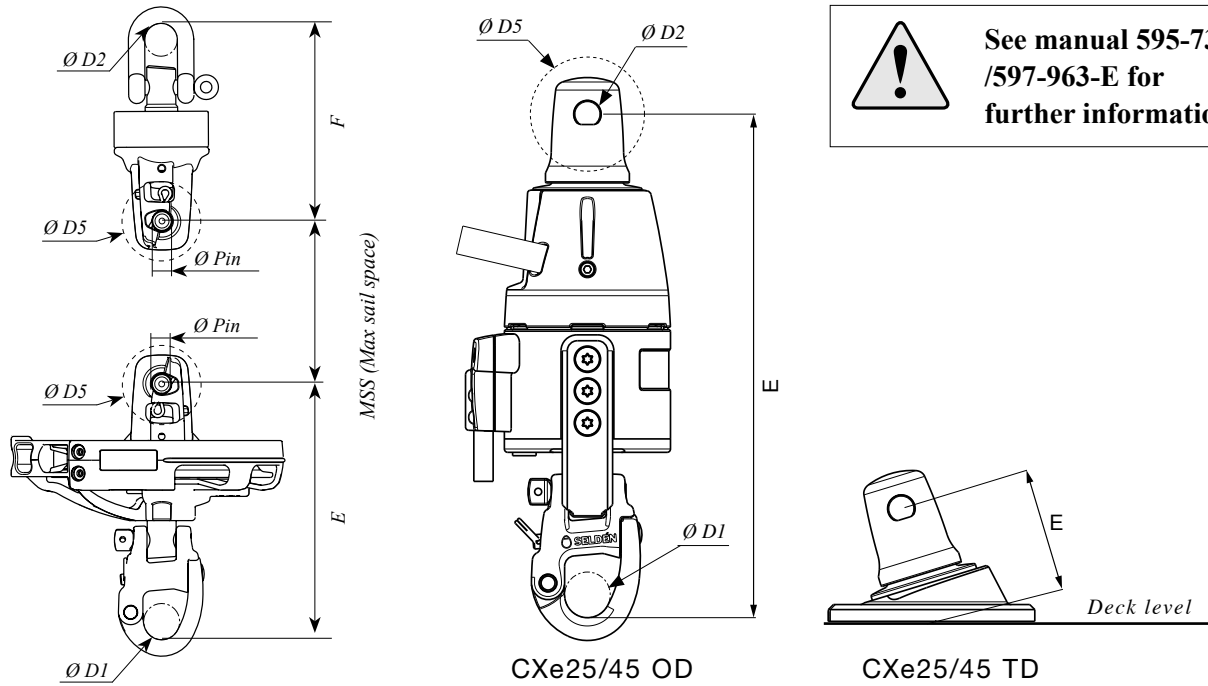

Fig. 7.6.d

Furlex Type/Serie	Section dimension	Luff groove mm	Max. space available in chamber mm	Max. luff tape mm	Cut-back CB mm	Maximum sail space FL-(F+E) (Measurement calculated from existing forestay length: FL).			
						F mm	E mm	F+E mm	
Hydraulic	C-Hydraulic	40/27	3.0	Ø 7	Ø 6	80	540	520	1060
	D-Hydraulic	50/34	3.0	Ø 8	Ø 6	100	620	675	1295
	E-Hydraulic	60/46	3.0	Ø 9	Ø 7	100	620	675	1295
	300H Ø 8	39/27	3.0	Ø 7.5	Ø 6.5	80	550	490	1040
	300H Ø 10	39/27	3.0	Ø 7.5	Ø 6.5	80	650	490	1140
	400H	48/34	3.0	Ø 8	Ø 6.5	100	620	610	1230
	500H	60/46	3.0	Ø 9	Ø 7	100	670	675	1345

8 Furling system CX & GX

8.1 Seldén CX, Furling system for Code 0 and stay sail



System	Maximum sail space (Measurement calculated from halyard shackle to fastening device on boat/bow sprit)			D1 mm	D2 mm	Ø Pin mm	Max fork space Ø D5 mm
	E mm	F mm	F+E mm				
CX10	115	90	205	14	12	10	40
CX15	125	95	220	16	12	10	40
CX25	155	120	275	22	20	12	45
CX40	190	145	335	24	24	16	55
CX45	190	145	335	24	24	16	66
CXe25 OD	285	120	405	22	20	12	64
CXe25 TD	70	120	190	-	20	12	64
CXe45 OD	300	145	445	24	24	16	68
CXe45 TD	70	145	215	-	24	16	68

Thimbles for AT-cables & AT-lines

System	Part no.	Ø Hole mm	D3 Max Ø AT-cable mm	W1 mm	H1 mm	H3 mm ¹⁾
CX10/15	545-114	10.3	9	16	45	18
CX10/15	545-116	10.3	11	16	45	18
CX/CXe25	545-216	12.3	13	19	56	21
CX40&CX/CXe45	545-416	16.3	16	20	59	27

1) For max Ø AT-cable

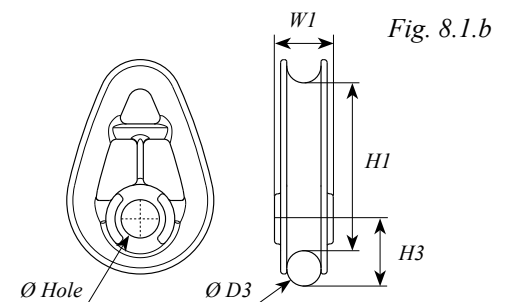

Thimbles for double luff rope

System	Part no.	Ø Hole mm	D4 mm	W2 mm	W3 mm	H2 mm
CX10/15	545-115	10.3	8	16	22	34
CX/CXe25	545-215	12.3	8	19	27	42
CX40&CX/CXe45	545-415	16.3	12	20	33	52

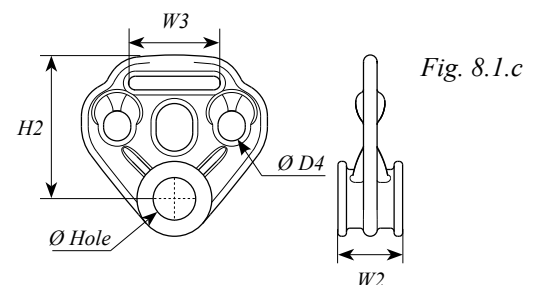

8.2 Seldén GX - Furling system for Gennakers/ Asymmetric spinnakers

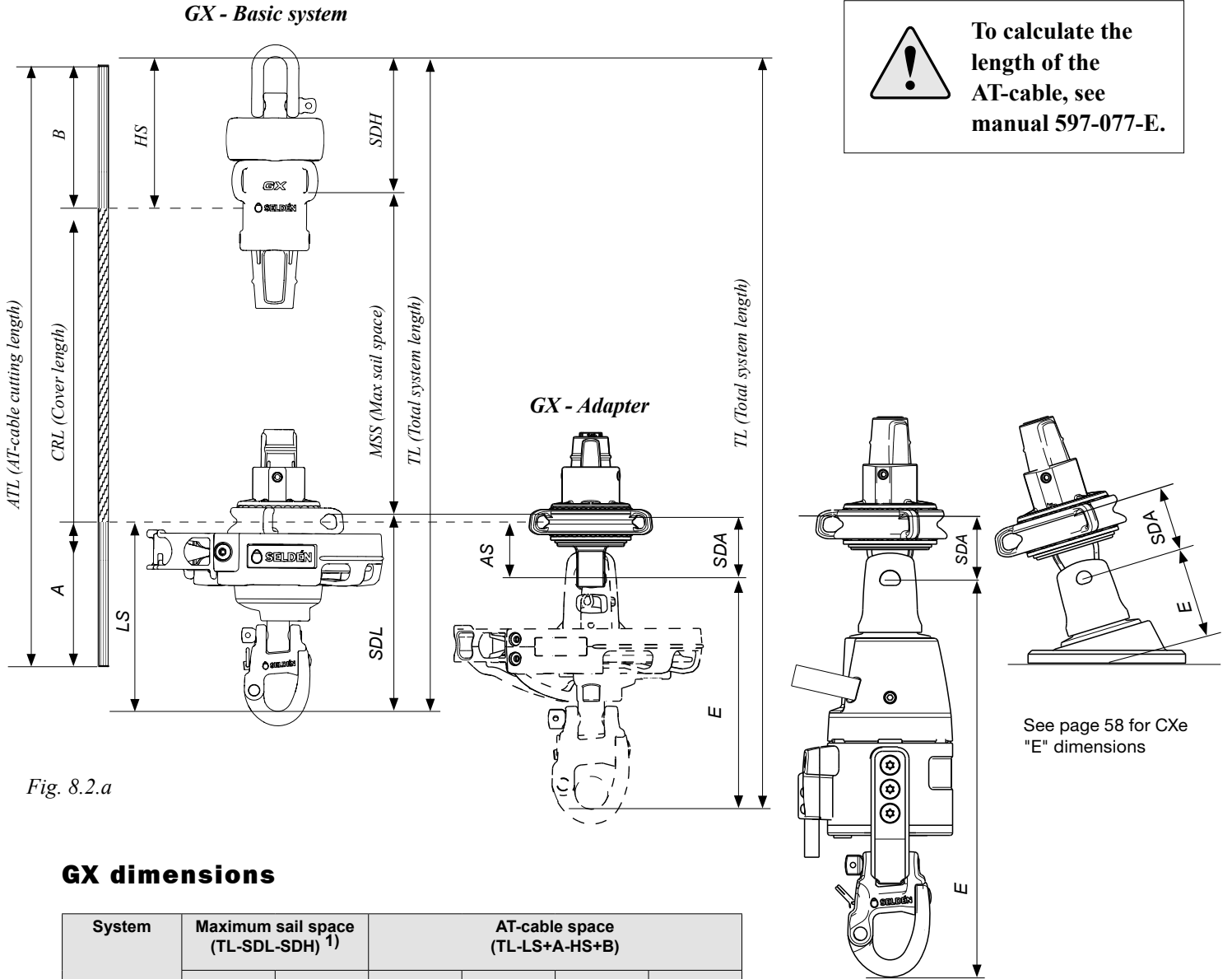

Fig. 8.2.a

GX dimensions

System	Maximum sail space (TL-SDL-SDH) ¹⁾		AT-cable space (TL-LS+A+HS+B)			
	SDL mm	SDU mm	LS mm	HS mm	A mm	B mm
GX7.5	100	70	100	70	120	120
GX10	105	70	110	70	120	120
GX15	115	80	120	75	120	120
GX25	155	100	155	95	150	150

¹⁾ System Maximum sail space includes space for lashing rope.

Dimension for GX tack adapter in combination with CX lower swivel

System	Adapter Part no.	AS adapter deduction	E CX lower swivel deduction	SDA sail deduction adapter
GX7.5 adapter - CX10	545-028-01	30	115	35
GX10 adapter - CX15	545-128-01	30	125	35
GX15 adapter - CX/CXe25	545-228-01	40	155	40
GX25 adapter - CX/CXe45 ¹⁾	545-428-01	45	190	50

¹⁾ Same values for CX40 as for CX45.

DINGHIESKEELBOATSYACHTS

Seldén Mast AB, Sweden
Tel +46 (0)31 69 69 00
Fax +46 (0)31 29 71 37
e-mail info@seldenmast.com

Seldén Mast Limited, UK
Tel +44 (0) 1329 504000
Fax +44 (0) 1329 504049
e-mail info@seldenmast.co.uk

Seldén Mast Inc., USA
Tel +1 843-760-6278
Fax +1 843-760-1220
e-mail info@seldenus.com

Seldén Mast A/S, DK
Tel +45 39 18 44 00
Fax +45 39 27 17 00
e-mail info@seldenmast.dk

Seldén Mid Europe B.V., NL
Tel +31 (0) 111-698 120
Fax +31 (0) 111-698 130
e-mail info@seldenmast.nl

Seldén Mast SAS, FR
Tel +33 (0) 251 362 110
Fax +33 (0) 251 362 185
e-mail info@seldenmast.fr

www.seldenmast.com

Dealer:

The Seldén Group is the world's leading manufacturer of mast and rigging systems in carbon and aluminium for dinghies, keelboats and yachts.

Our well known brands are Seldén and Furlex. The worldwide success of Furlex has enabled us to build a network of over 750 authorised dealers covering the world's marine markets. So wherever you sail, you can be sure of fast access to our service, spare parts and know-how.

SELDÉN and FURLEX are registered trademarks of Seldén Mast AB

